

Glow

Living Lights

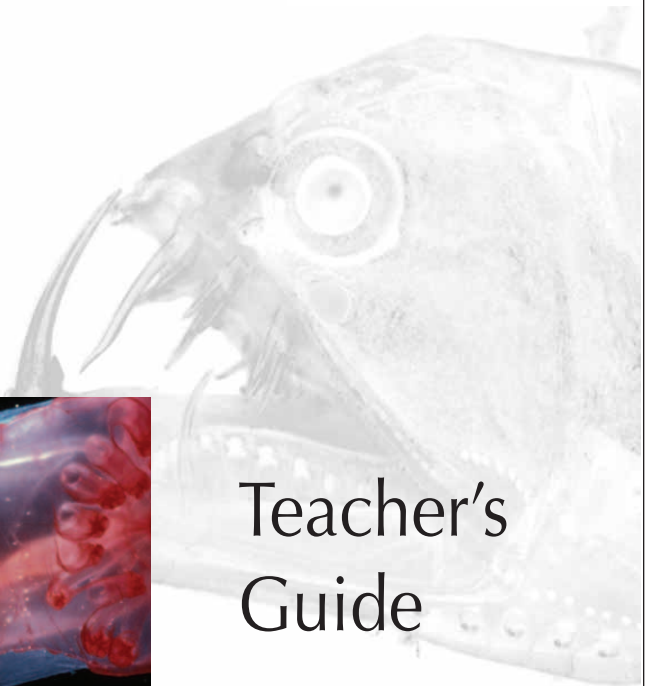
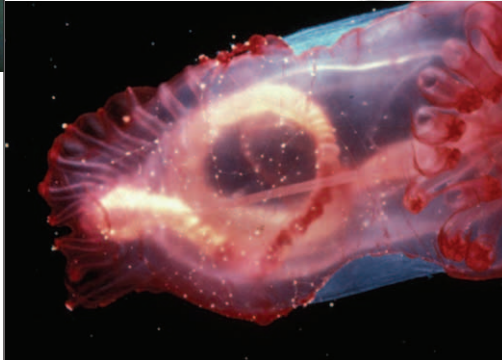
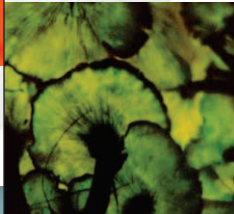
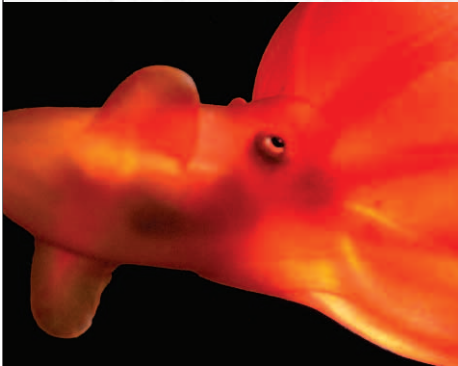
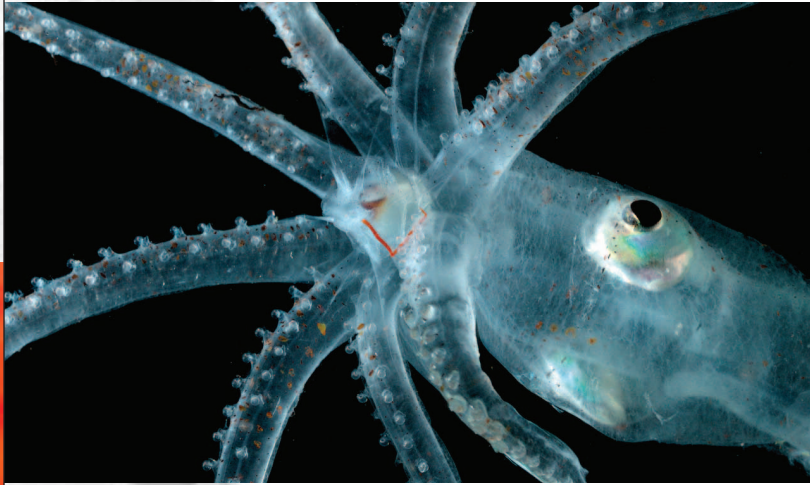
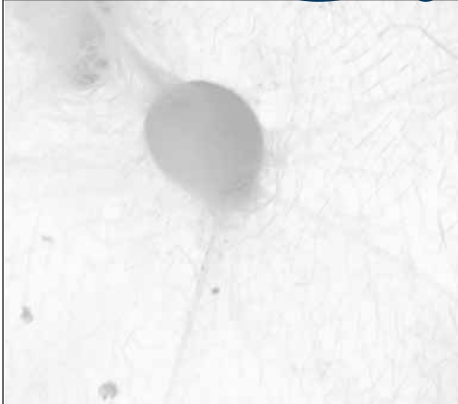

Teacher's
Guide

Introduction

Using this Guide	1
Alignment with National Science Education Standards	
About this Exhibit	2
Exhibit Floor Plan	
Quick Tips: Prepare for your Museum Visit	2
Topic Suggestions for Groups	

Content and Activities

1 What is Bioluminescence?	4
How Does the “Glow” Work?	
<i>A Chemistry Activity</i>	
Concepts	
• Light is energy	
• Cool vs. warm light	
• Observing and identifying chemical compounds	
2 “Living Light” Adaptation	8
Bioluminescence: In the Ocean?	
<i>A Science Activity</i>	
Concepts	
• Relatively rare on land, bioluminescence is common in the ocean	
• “Living light” is used primarily for camouflage in the open mid-ocean	
• Adaptation as an adjustment to fit into different circumstances or conditions	
3 Symbiosis Relationship	11
Flashlight Fish and “Glowing” Bacteria?	
<i>A Life Science Activity</i>	
Concepts	
• Some ocean creatures use bioluminescent bacteria as their light source	
• Link between bioluminescent bacteria and flashlight fish	
• Symbiosis as a mutually beneficial relationship	
4 Mysterious Light on Land	13
Who Glows There?	
<i>An Earth & Life Science Activity</i>	
Concepts	
• Fireflies are one of the best-known bioluminescent animals on land, yet there are other “glowing” terrestrial animals	
• Bioluminescence as a spectrum of colors	
• Connecting bioluminescent color and function	

5 Sparkling Coastal Seas15
What are Bioluminescent Dinoflagellates?
A Science Activity
Concepts

- “Sparkling seas” as a mixture of bioluminescent plankton
- Dinoflagellates as a type of plankton
- Light and dark cycles

6 Mid-Ocean Waters and Beyond18
What’s that Blue Light Everywhere?
An Earth & Life Science Activity
Concepts

- Taking an exploratory journey into the ocean with the submersible
- Challenges of the mid-ocean: Light, temperature, pressure
- Blue light dominates while bright red is recessive in the ocean

7 Structure of Life21
Organizing “Glowing” Organisms?
A Unifying Concepts & Processes Activity
Concepts

- Understanding how scientists organize life
- Reason why the universal system is so vital
- Organize and create own life structure using bioluminescent creatures

8 Defense/Survival & “Glow”24
Belly Lights, Burglar Alarms, & Vomiting?
A Life Science Activity
Concepts

- The three main “glowing” defense methods
- Change in light affects the light intensity of a “glowing” creature
- Bright light can aid in survival

9 Locating Mates & “Glow”26
Firefly Language: flash! (pause) flash! (pause)?
A Life Science Activity
Concepts

- Light aids in communication
- Male and female fireflies locate and recognize their mate through light flash patterns
- Creating “language” through codes of light

10 Finding Food & “Glow”	29
Cookie-Cutter Sharks and Vampire Squids?	
<i>A Life Science Activity</i>	
Concepts	
• Prey and predator	
• Utilizing light to locate or attract prey	
• Bioluminescent vs. non-bioluminescent organisms	
11 Practical Applications: People & Bioluminescence	30
Can Bioluminescence Reveal a Hidden Submarine?	
<i>A Science and Technology Activity</i>	
Concepts	
• Submarine as a hidden underwater vehicle	
• Masses of bioluminescent plankton can reveal an object or objects	
• Researchers learn from bioluminescent organisms	
12 Current Research	31
How can I become a Junior Scientist?	
<i>A Science Perspective Activity</i>	
Concepts	
• Common misconceptions of a “scientist”	
• Scientists in Glow Living Lights & their contributions to the understanding of bioluminescence	
• Potential research and careers in science	
Field Guide of Bioluminescent Creatures	34
Glossary	38
Resources	40
Acknowledgments	41

Teachers Guide

To Educators: The Virginia Marine Science Museum welcomes educators and students to **Glow: Living Lights**. This innovative exhibit reveals the remarkable behavior and ecology of bioluminescence. Bioluminescence is one of nature's most incredible phenomenon. It is also one of the least understood. Though relatively rare on land, it is prevalent in the mid-ocean where people don't often go.

Glow: Living Lights is an excellent platform for a number of scientific disciplines including chemistry, biology, ecology, and oceanography. Further, this exhibit dives into subjects including research methods, current and potential uses of knowledge being gained, and encourages careers in science.

Bioluminescence, or "living light," refers to the ability of living organisms to produce light through a chemical reaction. At night, bioluminescence appears as flashes of hundreds of fireflies or the sparkling trails in the sea. But hidden from view, in the depths of the oceans, are even more astonishing displays. In the twilight depths of the mid-ocean, where more than 90% of the animals make light, luminescence acts as a cloaking device, used to blind or distract predators, lure prey, and even attract mates.

There seem to be no end of ways that animals use their chemical lights. And now humans have learned to use these lights. Scientists use the chemical light from jellyfish to see inside cells, and the light from bacteria to test for pollutants. From creatures that make light to survive, we are discovering new ways to see into the unknown and perhaps thus aid our own survival.

Using this Guide

Use this guide to prepare students for their **Glow: Living Lights** exhibit experience. This guide will be invaluable for educators to generate student interest before, and beyond their visit. Inquiring activities link their curiosity about the "mysterious glow" into educational classroom lessons for grades third through sixth. Each lesson plan is presented at the level of third through fourth. Added features are included specifically for grades fifth through sixth. Please adjust it according to your class.

National Science Education Standards

This guide was created in alignment with the National Science Education Standards (1996) for grades and subjects indicated.

Materials

Several activities include materials such as sea fireflies or light sticks, not readily found in the classroom, that need to be purchased in advance. We understand purchasing classroom supplies is often difficult. Suggestions for alternate materials or quantity adjustments are also listed. In any case, a simple teacher demonstration will be invaluable.



Introduction

About this Exhibit

Glow: Living Lights is the first traveling exhibit to explore the incredible behavior and ecology of bioluminescence. This innovative exhibit explores how and why organisms create their own light. From the incredible depths of the mid-ocean to the suburban backyard, fascinating creatures both familiar and foreign are lighting up the dark. Organized and produced by ExhibitQ, **Glow: Living Lights** is the only practical way to experience this amazing occurrence.

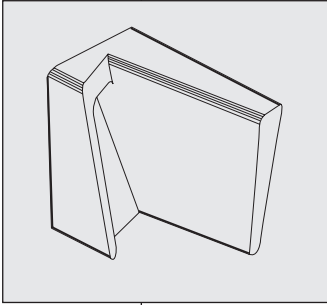

“Glow Block” Puzzle Design

As you enter the exhibit, you will notice **Glow: Living Lights** unique puzzle design. Specific subjects, such as fireflies, are presented on a single “glow block.” Like an interlocking puzzle, ExhibitQ’s innovative design emphasizes the larger picture of bioluminescence and its connection to ecology.

Highlights

- A dramatic walk-through mid-ocean gallery
- Scientifically accurate models, such as a cookie-cutter shark, vampire squid & Malaysian land snail
- Educational interactives
- A “walk-in” firefly laboratory
- Incredible photographs and film footage of bioluminescent animals in their environment

We’re Green!

All of ExhibitQ’s printing is on chlorine-free, post-consumer recycled paper (preferably tree free) using soy-based inks. All paints and lacquers used are non-polluting and environmentally safe. ExhibitQ is committed to seeking alternative methods that employ the three “R’s”- reduce, reuse, and recycle.

Universal Access

ExhibitQ strives to accommodate everybody, whether or not they have a disability. It’s more than complying with ADA regulations. It’s more than removing barriers. It’s being sensitive and creative to welcome all people into an exhibit experience.

Quick Tips: Prepare for your Museum Visit

Suppose some of your students decided to go on an (imaginary) exploration to find fireflies for a couple of days. They inform you that they will only take their sleeping bag and a flashlight. As an educator you would inquire: Do you know where you are going? What about a map, supplies, and food? What if it rains? Or if you got lost?

Preparing is a key element to making your museum visit an invaluable and enjoyable learning experience. Here are some quick tips and suggestions:

- 1) Discuss with your students their upcoming **Glow: Living Lights** visit. Present the exhibit map and highlights.
- 2) Provide background information and activities from this guide. The better the understanding of this subject, the more their exhibit experience will enhance inquiry and discovery. Museum exhibits offer a unique environment to illustrate scientific principles and knowledge.
- 3) Group students and involve Chaperones – museums recommend one adult per five students. Group five students with a chaperone. Each group can focus on a specific topic (listed below) to later discuss with the rest of the class. Inform chaperones of their group leader responsibilities and to assist with student inquiry.

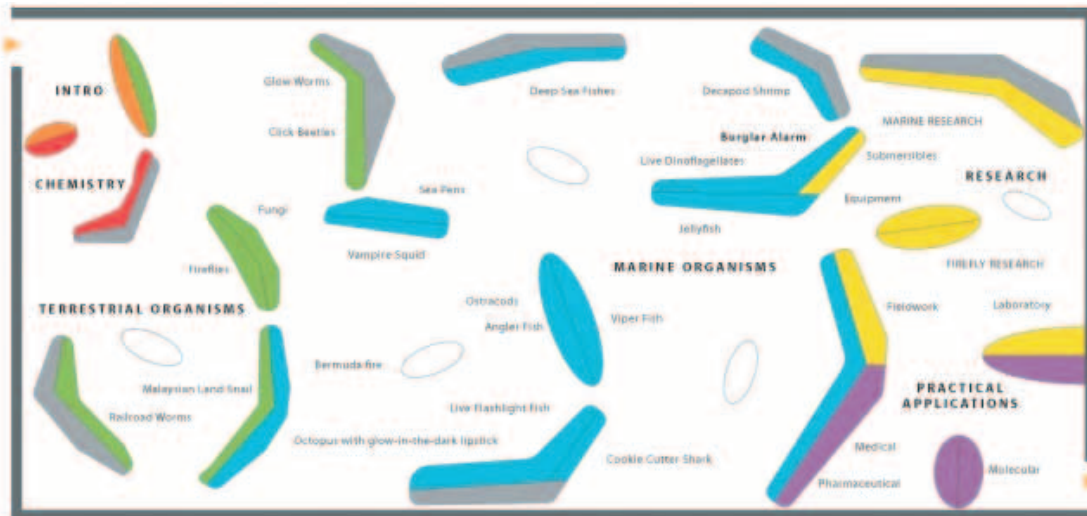

- 4) Before your visit, inform your students and chaperones about museum rules, time schedule, bathroom locations and lunch breaks. Answer any questions they might have. By eliminating distractions, students will be able to better enjoy their visit.
- 5) At the museum, encourage students to discuss what they are experiencing. Although each group will be focusing on a specific subject, allow ample time for students to explore and experience the entire exhibit.
- 6) If possible, pre-visit the museum and exhibit. Bring other accompanying instructors to enjoy the experience.
- 7) Remember to schedule your trip in advance to avoid disappointment.

Topic Suggestions for Groups

Prior to your **Glow: Living Lights** exhibit visit, link topic suggestions with student groups. Have groups discuss their topic with the rest of the class after their visit. These inquiries can lead to further discussion of larger issues including chemistry, oceanography, scientific research, and practical applications of bioluminescence.

- **Compare “bioluminescence” with “fluorescence.”** (EX: fluorescent rocks) What are the similarities and differences? Why do you think people confuse the two terms?
- **Use the firefly interactive,** located in terrestrial animals, to understand how fireflies communicate with each other. What flash sequence do you use to “talk” to the other firefly? Was the pause just as important as the light flash?
- **Watch the live flashlight fish.** Describe the flashlight fish and see what it is doing. What color is the bioluminescence? Can you see the bioluminescent bacteria in the special light organ underneath their eyes? How do you think the flashlight fish use their light source?
- **What are belly lights?** How do animals in the mid-ocean use lights on their belly to camouflage themselves in the ocean?
- **Bioluminescence and people.** Find out how the “glow” can help people by studying the “Practical Applications glow block.” Visit the “walk-in” firefly laboratory.
- **Look at the entire exhibit design.** What are these puzzle design “glow blocks?” What’s the connection between a “puzzle” and ecology? How does the quantity of species in a regional area determine the diversity?
- **On land, what other animals live in the dark that are not in this exhibit?** (EX: bats, owls) What other features or environmental circumstances do these animals have instead of bioluminescence to assist them in the dark? (Ex: bats use an echolocator, emission of sound waves, to help locate their prey)

1 What is Bioluminescence?

How Does the “Glow” Work?

A Chemistry Activity

Focus Questions: *Has anyone ever seen a firefly “glow” before? How do these and other animals create their light?*

Overview

This lesson plan begins with students own involvement with bioluminescence. (If no one has seen a live “glowing” organism, ask if anyone has seen a light stick.) Using light sticks, students will inquire and understand the chemistry behind these and other “glowing” creatures. A teacher demonstration of sea fireflies/ostracods will allow students to experience a bioluminescent creature. Upon visiting the **Glow Living Lights** exhibit, students will have a better understanding of this largely misunderstood phenomenon.

Concepts

- Light is energy
- Cool vs. warm light
- Observing and identifying chemical compounds

Objective

- Students will understand light is energy.
- Students will understand bioluminescence as a cool light.
- Students will identify chemical compounds and observe a chemical reaction.
- Students will understand the definition of bioluminescence.

Alignment with National Science Education Standard

Science as Inquiry: Content Standard A & B

- Abilities necessary to do scientific inquiry
 - Understandings about scientific inquiry
- Physical Science: Content Standard A & B
- Properties and changes of properties in matter
 - Light, heat, and electricity
 - Transfer of energy

Estimated Time: one class period

Materials

One for each student or group of students:

- Light stick (see Resources)
- Activity sheet
- Pencil & eraser

For teacher demonstration:

In addition to a very dark room,

- Sea fireflies/ostracods – purchased in advance (see Resources)
- One popsicle stick
- One small clear plastic cup
- Paper towel
- One small cup of water

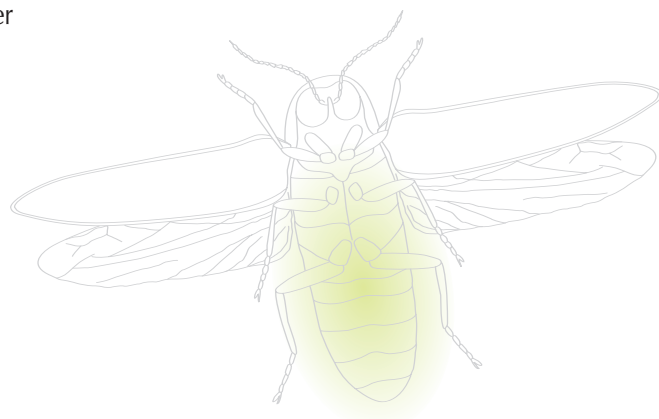

Preparation

Mail order light sticks and sea fireflies in advance. (You might be able to purchase light sticks at a supply or diving store – see Resources) Familiarize yourself with the procedure of the sea firefly demonstration. Photocopy activity sheets & prepare materials.

Background Information

Bio means life and *luminescence* means light, or together “living light.” Bioluminescence or “living light” refers to the ability of living organisms to produce light through a chemical reaction. Although relatively rare on land, about 90% of animals in the deep ocean create their own light. Animals use their light to lure prey, evade predators, and attract mates.

Light is a form of energy. For most light, like a light bulb, energy is used to produce heat. An average light bulb wastes about 97% of its energy on heat. However, energy to create light can also come from a cool, light-energy source that does not produce heat. Cool light is created by a chemical reaction. Scientists have discovered “glowing” organisms create this cool light from chemicals mixed together inside their bodies. Although the two chemicals which create light are called luciferin (substrate) and luciferase (enzyme), different animals produce different versions of these chemicals. Different bioluminescence can create different colors and varying degrees of light intensity.

One thing all these chemicals have in common is that they must react with oxygen and ATP to produce light. ATP (adenosine triphosphate) is an energy package found in all living cells. (Ex. blinking our eyes is powered by ATP)

The chemical compounds in sea fireflies (ostracods) are found in a place below their lower jaw. Sea fireflies are a class of crustaceans- such as crabs. Tiny in length (0.5 to 5 mm), sea fireflies are about the size of a tomato seed. Their body is enclosed within a hinged bivalve shell, like a clam. They live on the sea bottom during the day and then go up to feed at night. The males swim around and release bright blue bioluminescent drops to find female sea fireflies.

The chemical compounds in light sticks are activated when they are bent and then shaken. Although light sticks and other man-made objects are not bioluminescent, they are very similar in terms of a cool light and a chemical reaction. Recent advances in technology have resulted in most chemiluminescence (light produced by a chemical reaction) products lasting between 6 to 12 hours.

Procedure**1. Introduction to “the glow.”**

Begin with a discussion of what your students already know about the “glow.” Ask students if any of them have seen a firefly or any other similar creatures. Have one or two students share their experience.

2. How to make the light in the light stick

- a. Ask students how they think fireflies and other “glowing” animals make their light (*results will vary*).
- b. Show students a light stick. Ask students how they think they can activate the light in the light stick. Pass out the light stick, activity sheet, and pencil/eraser to each student or group of students. Turn off the lights. Tell students to write down their initial hypothesis, observations, and results. (The answer is the light stick will light when broken and then shaken.)

- c. To help students, ask them to shake their light stick. (The answer is nothing will happen.) What happens when they bend the light stick? (initial light) How can they make the initial light spread throughout the rest of the stick? (shake it)

3. What is bioluminescence?

- a. Define: *bio* means life and *luminescence* means light so together it means “living light.” Explain to your students that animals such as fireflies make a light similar to the light stick except it is created in the animal’s own bodies.
- b. Explain to your students that light is energy. Unlike a light bulb which wastes about 97% of its energy on heat, energy needed to produce light can come from mixing chemicals together. This is called a cool light, because the energy source is not heat. Ask students if the light stick was warm or cool. (The answer is cool) Remind your students of how they activated the light sticks. When they broke and shook their light sticks, they mixed chemicals together, and the result was light.
- c. Explain that fireflies have essentially two chemicals inside their bodies which mix to produce light. The process also requires the elements of oxygen and ATP.
- d. Compare a terrestrial firefly with a sea firefly. On land, fireflies make a flashing light which is either yellow or green. Male and female fireflies use their lights to communicate with one another. A sea firefly (ostracod) is a tiny organism which lives in the ocean. The male ostracod produces a bright blue light to attract the attention of the female. Explain that although the end result is light, each type of animal creates different versions of the chemicals to create different types of light.
- e. Turn off the lights and demonstrate the bioluminescent light in the sea fireflies. The room will have to be very dark to be most effective. Place some sea fireflies in a clear cup. Use your popsicle stick to crush them. Explain to your students you are mixing the chemicals together. Notice they will not activate until you mix the chemicals. Add water and then stir the mixture. (additional element of ATP- stirring motion)
- f. Inform students they will be seeing numerous bioluminescent creatures and learning why they glow on their **Glow: Living Lights** visit.

Assessment

Use student responses and the activity sheet to gauge student understanding.

Light stick activity

1. How do you think you can make the light stick “glow?” _____
2. Shake it. Did anything happen? _____
3. Break it in half. What do you see? _____
4. Then, shake it again. What happened? _____
5. What color light is it? _____
6. Is it cool or warm to touch? _____
7. Write how you made the light stick “glow.” _____
8. Were numbers one and seven the same? If not, how were they different? _____



For Grades 5 – 6th

Overview

In addition to bioluminescence, students will be introduced to chemiluminescence, phosphorescence, and fluorescence. These terms are commonly misunderstood as the same type of “glow.”

Definitions

Chemiluminescence is light produced by a chemical reaction and not by heat. Bioluminescence, light created inside the organism, is a subset of chemiluminescence. This type of light includes light sticks and other man-made products.

Fluorescence (ex. fluorescent rocks) is a light emission stimulated by radiant energy, not by a chemical reaction. The emission of short rays is absorbed and then bounced off. Because of the absorbed light, electrons inside the rocks are kicked into an excited state (i.e. – they “glow”). But the electrons are unstable and they soon return to a lower level. Therefore, fluorescent rocks only “glow” when there is another light source, such as UV light, shining upon them.

Phosphorescence (ex.: glow-in-the-dark paint) is similar to fluorescence. The difference is that the electrons are more stable in their excited state. This makes the glowing light last for a much longer time, even after the external light is removed. Phosphorescence is the delayed emission of light that has been excited by another light source.

Materials

One each for rotating stations:
 Light sticks (one for each group of students)
 Glow-in-the-dark object
 Fluorescent rocks (see Resources)
 UV or black light

Preparation

Obtain materials. Place the following object(s) into rotating stations for students to examine different types of “glow.” Photocopy activity sheets.

Light stick (chemiluminescence)
 Glow-in-the-dark object (phosphorescence)
 Fluorescent rock (fluorescence) & black light

Procedure

1. Introduction to bioluminescence and other types of “glow”

In addition to the light stick, ask students how they think they can activate the other types of light. Have your students discuss if they believe all these lights are the same. Pass out activity sheets and pencil/ eraser. Tell students each group will rotate to different stations.

2. What are all these confusing terms: chemiluminescence, phosphorescence, & fluorescence?

Introduce the terms: Chemiluminescence, Phosphorescence, & Fluorescence. Explain to your students the different types of “glow” and in detail, how they are activated. Ask your students again if they believe all these types of light are the same. (The answer is they are not. They are all activated differently. Thus all these lights are different from bioluminescence and each other.)

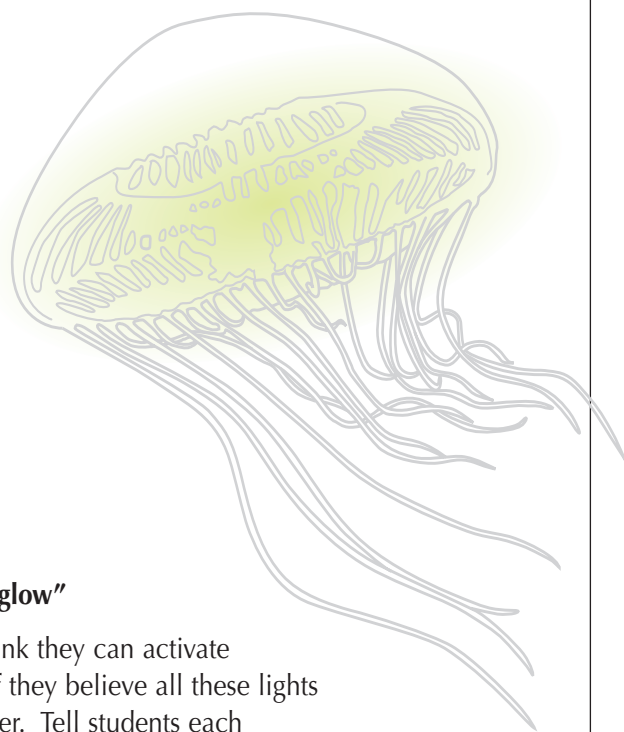

Different Types of “Glow”

Light stick Glow-in-the-dark object Fluorescent rocks

Hypothesis (How to turn on the “glow?”)

Did the object need an additional light source?

If so, what type of light was it?

What other observations did you make?

Conclusion (result to make them “glow”)

Was your hypothesis and conclusion the same?

If not, what was different?

2 “Living Light” Adaptation

Bioluminescence: In the Ocean?

A Science Activity

Focus Questions: *Relatively rare on land, bioluminescence is common in the ocean. What is the main environmental factor? How do camouflage, function, and adaptation play into this?*

Overview

Though relatively rare on land, about 90% of creatures living in the mid-ocean produce bioluminescence. The following activity will answer the “why?” in this statement. “Living light” creatures use bioluminescence to find food, locate mates, and scare predators. However, in the mid-ocean there is an additional environmental factor. “Living light” creatures have adapted to fit into their specific environment. In this activity students will create and experiment with their own bioluminescent fish in the mid-ocean to understand this adaptation.

Concepts

- Relatively rare on land, bioluminescence is common in the ocean
- “Living light” is primarily used for camouflage in the open mid-ocean
- Adaptation as an adjustment to fit into different circumstances or conditions

Objectives

- Students will learn bioluminescence is rare on land but common in the ocean
- Students will understand in the mid-ocean, bioluminescence is primarily used for camouflage
- Students will identify bioluminescence as an adaptation

Alignment with National Science Education Standard

Life Science: Content Standard C

- The characteristics of organisms
- Organisms and environments
- Diversity and adaptations of organisms
- Populations and ecosystems

Estimated Time: 1 class period

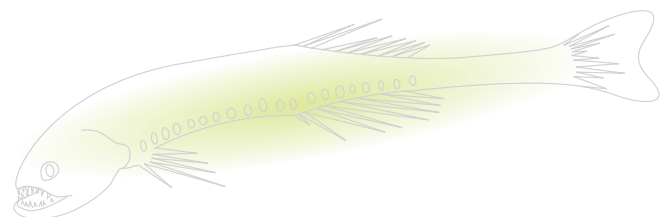

Materials

One for each student or group of students:

- Black construction paper- three 8.5" x 11" sheets
- White construction paper- half an 8.5" x 11" sheet
- Two popsicle sticks (pre-painted black)
- Activity sheet
- Pencil & eraser

Optional- string
Clear tape to share

Preparation

Familiarize yourself with the procedure and the black/white fish activity. Make an example of the activity. Pre-paint popsicle sticks. Pre-cut fish silhouettes, construction paper, and appropriate construction paper sheets. Prepare materials.

Background

About 90% of living space on earth is underwater, making the ocean by far the earth's predominant habitat. Most of this water is continuously dark. Sunlight does not reach the deep depths of the ocean. The only light comes from bioluminescent creatures lighting up the dark. However, the main reason bioluminescence is rare on land but common in the ocean is because of the unique visual characteristics of the ocean environment.

Although bioluminescence is found in all oceans at all depths, the greatest numbers are found in the upper 600 feet of the vast open ocean. This is a place where there is nowhere to hide, and where sunlight filters down through the depths. In this twilight realm where the light is dim, and directed downwards, creatures have adapted to camouflage themselves in the light. By matching the sunlight or moonlight intensity shining from above, creatures become "invisible" with their own lights.

Adaptation means to gradually change in structure, form, or habits to fit into different conditions in order to survive. This is the reason why certain fish such as the hatchetfish have upturned eyes and upturned mouths. By focusing in the direction of the light, they are able to see the black silhouette of a swimming creature and find their next meal.

However, the hatchetfish is also prey to even bigger animals swimming below it. So to make itself harder to see, the hatchetfish has a narrow silhouette and silver sides. The creature also emits bioluminescence from its photophores or belly lights, which perfectly match in color and intensity the sunlight filtering down from above.

Bioluminescence, in this case, acts as camouflage, meaning to disguise in order to conceal. Camouflage allows creatures to "blend" with their background to conceal them from a predator. In the twilight depths, the silhouette of an animal is seen against the dim blue light filtering down from above. Creatures with bioluminescence have a better chance to go undetected and thus have a better chance for survival.

Procedure**1. Introduction to bioluminescence being common in the ocean.**

- a. Begin by asking students in what type of environment would an additional light source be the most useful. (dark environment without light blocking obstacles)
- b. Inform students that bioluminescence is rare on land but common in the ocean. Explain the mid-ocean, how light filters in the ocean, and the reason why it is dim in the mid-ocean.

2. What is adaptation?

Explain adaptation by using the hatchetfish as an example. “Living light” creatures have adapted to fit into their specific environment

3. Bioluminescence as a type of camouflage?

Meaning to disguise in order to conceal, camouflage allows creatures to “blend” with their background to conceal them from a predator. Explain how certain bioluminescent animals have belly lights and how it helps them to camouflage in mid-ocean.

4. Black/ white fish activity

- Pass out material. Each student or group should receive two fish (made of black construction paper), half sheet of white paper, two half sheets of black construction paper, and the additional supplies. Pass out activity sheets.
- Explain the activity to the students. One fish will be a creature without bioluminescence. The other fish will be a bioluminescent creature. (punch holes in this fish). Explain to the students they will be determining which environment best suits which fish. (the white sheet represents the top layer of the ocean, the sheet with holes represents the mid-ocean, the solid black sheet represents the deep ocean)
- Each group should hold or hang their sheets (one just the black construction paper, the other with holes) up to the light (where sunlight will shine through). Have students tape the fish to the sheet to determine their results.

Assessment

Use student responses and the activity sheet to gauge student understanding.

For Grades 5 – 6th

Overview

In addition to the above activity, students will inquire and understand the following question: What happens when the light intensity changes such as a cloud passes over the sun or the moon?

Background Information

If a cloud goes over the sun, dimming the sunlight or moonlight, the fish dims its bioluminescence so it continues to blend into the background. Turning the light on lower or higher in light intensity is called counterillumination.

Material

Additional 1/2 sheet of black construction paper

Procedure

1. Introduction to counterillumination

In addition to the above activity, students should cut two parallel lines on the fish with holes to slide a piece of black construction paper. This will enable students to slide the piece of paper back and forth to allow more or less light to demonstrate counterillumination.

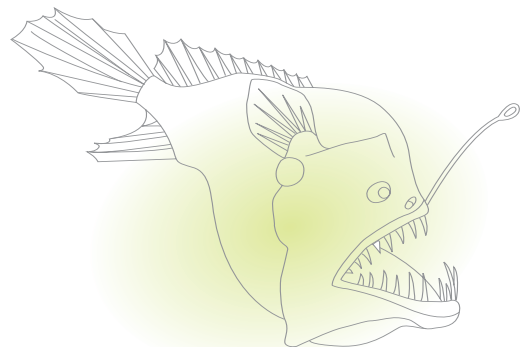

3 Symbiosis Relationship

Flashlight Fish and “Glowing” Bacteria?

A Life Science Activity

Focus Questions: *Some animals do not create bioluminescence yet they still “glow.” How is this possible? What is the connection between flashlight fish and bioluminescent bacteria?*

Overview

Most animals make their own living light. Yet, some marine animals are not bioluminescent and still “glow.” How is this possible? Some animals, such as the flashlight fish, have a special chamber to store bioluminescent bacteria. Bacteria need a home and nutrients, and the flashlight fish and other creatures need a light source. It is a mutually beneficial relationship. Using blindfolds, students will work together to understand this amazing occurrence.

Concepts

- Although most animals create “glow” from chemicals in their own bodies, some use bioluminescent bacteria as their light source
- Link between bioluminescent bacteria and flashlight fish
- Symbiosis as a mutually beneficial relationship

Objective

- Students will learn and understand bioluminescent bacteria
- Students will understand that symbiosis is when two unlikely organisms work together in a mutually beneficial relationship
- Students will identify the reasons behind this arrangement

Alignment with National Science Education Standard

Life Science: Content Standard C

- Characteristics of organisms
- Organisms and environments
- Diversity and adaptations of organisms

Estimated Time: one class period

Materials

For teacher demonstration:

Flashlight

One for each pair of students:

Blindfold

2 plastic cups

Assorted dry beans or macaroni (1/4 cup per student)

Preparation

Familiarize yourself with the activity. Students will pair up for this activity. Arrange furniture so that each pair will be facing each other. Prepare materials.

Common Misconception

Myth: *Most bioluminescence comes from bacteria.*

Truth: *Bacteria can be luminous and some organisms like flashlight fish and squid do have bacteria in their light organs. However, most bioluminescent animals are able to produce light with chemicals they have stored in their own bodies.*



Background Information

Some ocean animals do not produce their own living light. They “borrow” bioluminescent bacteria as a light source. “To borrow” means to get something from another person with the understanding that it will be returned. However, a “borrower” as in the case of the flashlight fish, does not return its light. The flashlight fish and bioluminescent bacteria develop a permanent partnership.

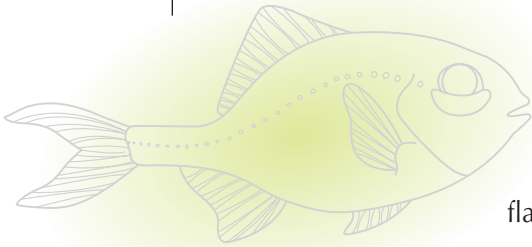

Flashlight fish (about 6 inches in length) live in the Indian Ocean and the South Pacific. They live in reefs and rocks near shore where they hide during the day. When it becomes dark, they come out to feed. Flashlight fish use their light to find prey. Also, many of the plankton that they eat are attracted to their lights similar to the way moths are attracted to a flame. Flashlight fish also use their light for defense. They swim up to a predator, flash their lights, and then zig-zag away to confuse it.

In the flashlight fish, bioluminescent bacteria are located in the light organ underneath its eyes. The size of a kidney bean, the light organ is home to about a billion bacteria. The “glowing” light is crucial for the flashlight fish’s survival, and the fish provide the bacteria a home and nutrients. This mutually beneficial arrangement is known as symbiosis.

Procedure

1. Introduction to a “Borrower”

- Inquire of your students if they can define the term, “borrow.” Describe the difference between “borrow” and a “borrower” as it relates to symbiosis.
- Ask your students- but isn’t bacteria usually harmful? Some bacteria, which are so tiny that most can only be seen through a microscope, can make us sick, but certain other ones can be really helpful, like in this case.

2. Why are flashlight fish linked with bioluminescent bacteria?

- Describe the symbiosis relationship. Link the flashlight fish and bioluminescent bacteria. Using the flashlight, demonstrate this arrangement. (put the flashlight beneath your eye.) Like a flashlight, the bioluminescent bacteria helps the fish find food or attract food to come to the fish. In return, the fish provides the bacteria with a home and food which they need to grow.
- Explain how to most creatures, being eaten is not a good thing, but for the bioluminescent bacteria, it gets them a safe and comfortable home inside the fish’s body. The glow of these bacteria can also work to attract fish to eat them.
- Explain symbiosis as a mutually beneficial relationship and explain the symbiosis relationship activity.
- Pair students. One student will be the “flashlight fish.” (with the cup) and one student will be the “glowing” bacteria (with the assorted beans.) Pass out materials. Blindfold the “flashlight” fish.
- Explain the rules. The “flashlight fish” will have to get the assorted beans (one at a time) from the “bioluminescent bacteria”. The “fish” can only use one hand. The “bacteria” can only hold one bean at a time at a distance from the desk. As the light for flashlight fish to “see”, bioluminescent bacteria can verbally tell the fish where their hand with the beans is: ex. an inch more, higher, etc.. When they complete the activity, switch places.
- The pair who can do it the fastest, wins.

Assessment

Use student responses and the activity sheet to gauge student understanding.

For Grades 5 – 6th**Overview**

Create difficulty by selecting certain “bacteria” not to “glow.” Inform certain “flashlight fish” they are “in the dark” and will not get instructions as to where the beans are held. Set a time limit.

Procedure

1. Inform certain “bacteria” and “flashlight fish” that the glowing bacteria are not available and they must find the mixed beans on their own.
2. Set a time limit.
3. Discuss the advantages and difficulty in having or not having their “glowing light.”

4 Mysterious Light on Land**Who Glows There!*****An Earth & Life Science Activity***

Focus Questions: *Aside from the well-known firefly, what other terrestrial animals create their own light? What is the connection between bioluminescent color and its function? These and other intriguing questions will be answered in the following activity. Linking creatures with their bioluminescent color and function, students will understand how the glow light plays a role in helping an animal survive.*

Concepts

- Fireflies are one of the best-known bioluminescent animals on land, yet there are other “glowing” terrestrial animals
- Bioluminescence as a spectrum of colors
- Connecting bioluminescent color and function

Objective

- Students will learn about uncommon terrestrial animals
- Students will understand there are many types of bioluminescent animals and different bioluminescent colors
- Students will learn that bioluminescent color plays a role in helping an animal survive

Alignment with the National Science Education Standards

Life Science: Content Standard C

- The characteristics of organisms
- Life cycle of organisms
- Organisms and environments
- Structure and function in living systems
- Diversity and adaptations of organisms

Earth and Space Science

- Properties of earth materials
- Structure of the earth system

Estimated Time: 1 class period

Materials

- One for each group of students:
- Activity sheet
 - Pencils/ erasers
 - Colored markers

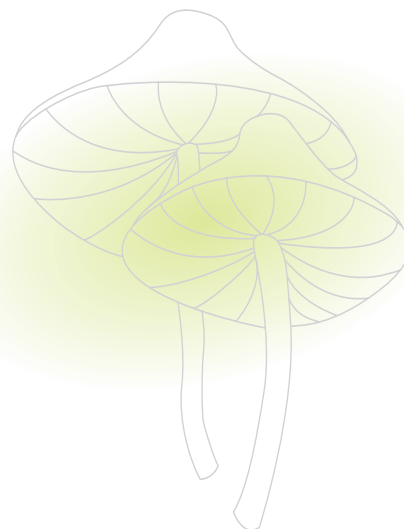

Computer and internet access

Download images of various terrestrial creatures (see Resources- website)

Preparation

Prepare materials. Download images of various terrestrial creature images as reference material.

Background Information

1. Introduction to bioluminescent terrestrial creatures
 - a. Explain the term terrestrial. Although there aren't as many bioluminescent terrestrial (land) creatures as marine (in the ocean) animals, there are some fascinating and colorful bioluminescent creatures living on land.
 - b. Show students pictures of each terrestrial animal. Describe the creature and their use of bioluminescence in terms of color and function. The color of their bioluminescence plays a crucial role in its function.

Malaysian land snail

The Malaysian land snail has a reddish-brown shell and a creamy white body. Green bioluminescence comes from a light organ on the underside of its body. Green is the color of bioluminescence most often found in land dwellers. It is the color which best effects the green plants that surround them.

Railroad worm

The railroad worm isn't actually a worm but rather a female beetle in larvae form. It has two red lights like headlights that shine when it is resting. When it is disturbed, greenish-yellow lights glow along its sides, like the lighted windows of a railroad train. It uses the greenish-yellow lights to scare away predators and uses its red lights like a sniper scope. This allows the creatures to be able to see without being seen.

Bioluminescent Click Beetle

Click beetles have an amazing ability to snap their bodies. The body flip makes a clicking noise. This helps them to quickly get away. One type of click beetle has two orange glowing spots on its body that looks like a pair of glowing eyes. Besides the light on its body, it also has two yellow light organs on its back.

New Zealand Glowworms

These glowworms are not firefly larvae but are the larvae of a certain type of fly. They live in caves and actually use their lights to help catch their food. Like spiders, they spin sticky thread that they hang down from the ceiling to use like fishing lines. Flying insects attracted to the light get caught on these lines. The glowworms reel up their fishing lines, gobble up the captured creature, and then throw the line back for another catch.

Firefly Glowworms

Larvae and some species of female fireflies are called glow worms. The confusion lies behind two different types of beetle and fly larvae labeled as glow worms.

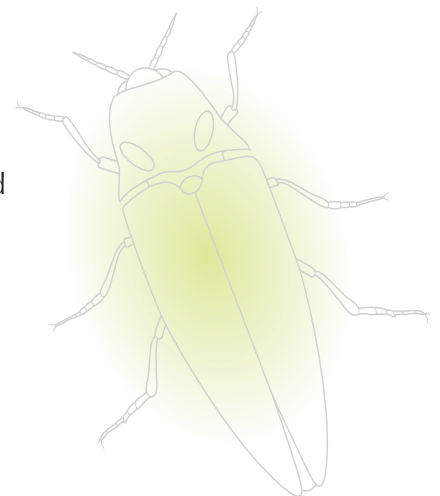
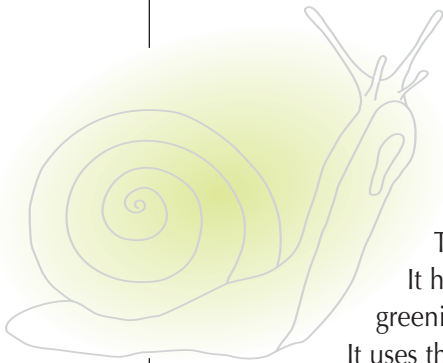

2. Assessment

Have students conclude this lesson by doing the activity sheet. Have students link the bioluminescent creature with its bioluminescent color connection.

Link appropriate bioluminescent color with their function.

Railroad worm Red (like a sniper scope) headlights: Flashing yellow/ green lights	Scare away a predator
New Zealand glowworm Steady bright yellow light	Attract a flying insect
Bioluminescent click beetle Flashing orange lights	Like a sniper scope, to see without being seen
Malaysian Land Snail Trail of green light	To find another of their own species

For Grades 5 – 6th

Overview

In addition to the above activity, students will inquire and understand what is the predominant bioluminescent color on land and why. Although terrestrial creatures create bioluminescence that ranges from red to green, the main terrestrial color is green. But why? The reason is because green light best mimics the green vegetation.

5 Sparkling Coastal Seas

What are Bioluminescent Dinoflagellates?

A Science Activity

Focus Questions: *What is the sparkling coastal seas? What are bioluminescent dinoflagellates? What are light/ dark cycles?*

Overview

Have you ever seen the coastal ocean sparkle a mysterious blue-greenish color at night? Looking closely at this sparkling light, students will learn about bioluminescent dinoflagellates. Bioluminescent dinoflagellates, a type of plankton, flash their lights at night while producing very little light during the day. In this activity, students will learn all about these amazing creatures and understand their light/ dark cycles.

Concepts

- “Sparkling seas” as a mixture of bioluminescent plankton
- Dinoflagellates are a type of plankton
- Light and dark cycles

Objective

- Students will learn why plankton and other tiny organisms are so vital to the food chain
- Students will understand dinoflagellates and how they grow
- Students will conduct a scientific experiment with dinoflagellates- different light and dark cycles

Alignment with National Science Education Standard

Science as Inquiry: Content Standard A & B

- Abilities necessary to do scientific inquiry
- Understandings about scientific inquiry

Life Science: Content Standard C

- Characteristics of organisms
- Life cycles of organisms
- Organisms and environments

Estimated Time: one class period- initial activity/ on-going experiment

Materials

- Dinoflagellates (see Resources)
- 12 hour timer
- four watt fluorescent light bulbs and attachments
- white shoe box
- Thermometer
- Petri dish
- Small fan
- Sterile sea water (see Resources)- optional
- one microscope

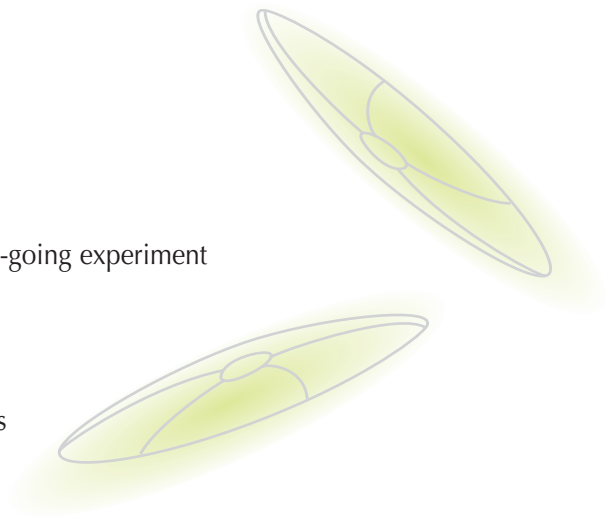

Preparation

Pre order dinoflagellates. Keep in mind this will be an on-going project with an initial introduction and conclusion for results. This lesson will take one to three weeks to accomplish. Prepare materials. Photocopy activity sheets.

Technical information about dinoflagellates

Dinoflagellates can glow during the night and do not glow during the day. However, using artificial light, we can change their light/ dark cycle. Place the light bulbs so that it will light inside the box. Set the timer to be set off every 12 hours. The easier way to control the cycle is to put dinoflagellates under a fluorescent light controlled at all times. Be careful not to let the cultures get too warm. They grow best at about 20 degrees C (68 Degree F). You can use a small fan blowing over the cultures to keep them cool while the lights are on. If the cells are maintained at the right temperature and with enough light each day, they will survive in their sealed bags for many months. The cultures can be maintained indefinitely by transferring them to a mixture of sterile sea water and nutrients every 2 or 3 months.

Background Information

Bioluminescence is often visible at night as a sparkling trail behind a boat in the ocean. Most of the flashing bioluminescence is from tiny creatures called plankton. Plankton play an important role in the oceanic food chain. These tiny creatures are eaten by other creatures, who in turn are eaten by other larger creatures and so forth. Most plankton are tiny and some can only be seen through a microscope. Most dinoflagellates are photosynthetic and receive their energy from the sun. The brighter the sunlight, the brighter the dinoflagellate's luminescence will be. Not all of these creatures are photosynthetic. Zooplankton receive their nutrients by eating other plankton. Some plankton are bioluminescent. The flash of light they create helps scare away animals that try to eat them. It can also work as an alarm to show other larger predators there is available prey.

Procedure**1. Introduction to the “sparkling seas”**

- a. Ask your students if they have ever seen the “sparkling seas.” If they haven’t, ask what they would think if they saw the ocean “glowing”? What would they think it was caused by?

2. Dinoflagellates are tiny single-celled creatures. Some kinds are bioluminescent.

- a. Explain that dinoflagellates are tiny single-celled creatures. Some are plant-like (photo synthetic), which means they get energy from the sun, while others are animal-like (zoo plankton), which means they get energy by eating other microscopic creatures. Some species of dinoflagellates are bioluminescent.

3. Dark/light cycles

- a. Inquire to your students as to what they look like and when do they use their bioluminescence? Have students look at the bioluminescent dinoflagellates under the microscope.
- b. Ask your students how they think we can see them glow during the day time since they normally use their lights only during the nighttime. Using artificial light, students will hypothesize how long it will take this cycle to reverse.
- c. Each day, students will keep a log of their observations.
- d. In about a week, the cycle should reverse and students will be able to see dinoflagellates glow during the day.

Discuss with your students the results.

Assessment

Use student responses and activity sheets to gauge student understanding.

For Grades 5 – 6th**Overview**

Students will learn about the next day phase by putting some dinoflagellates into a dish and adding a few drop of vinegar. They will examine what happens each day as the light emission is exhausted in this experiment. Another alternative would be to swirl the dinoflagellates in a flask until the same result occurs.

Material

vinegar

Procedure**Introduction to next day phase**

- a. Ask your students about after their next day phase. Have them separate the dinoflagellates into smaller containers. Either add a few drops of vinegar (you should see the cell glow instead of flash) or swirl the container around until the bioluminescent light supply is exhausted.
- b. Hypothesize if the exhausted supply will replenish by the next day.

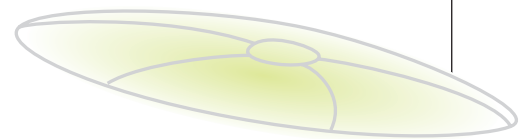

6 Mid-Ocean Waters & Beyond

What's that Blue Light Everywhere?

An Earth & Life Science Activity

Focus Questions: *What are the challenges of light to creatures living in the mid- to deep ocean waters? How does bioluminescent color play a role in the survival of "glowing" creatures?*

Overview

Using a submersible, students will take an exploratory journey into the mid-ocean to understand the challenges of ocean exploration. In addition to light, temperature, and pressure, students will learn that bioluminescence color plays a key role. In this activity, students will create an underwater world where colors will be inquired and experimented to understand how blue light is dominant while, oddly, bright red can make a creature "invisible" to predators.

Concepts

- Taking an exploratory journey into the ocean with the submersible
- Challenges of the mid-ocean: light, temperature, pressure
- Blue light dominates while bright red is recessive in the ocean

Objectives

- Students will understand the challenges of deep sea exploration
- Students will understand the color relationship and the organism
- Students will understand the color changes in the deep ocean

Alignment with National Science Education Standard

Science as an Inquiry: Content Standard A & B

- Abilities necessary to do scientific inquiry
- Understandings about scientific inquiry

Life Science: Content Standard C

- Structure and function in living systems
- Diversity and adaptations of organisms

Earth Science: Content Standard D

- Structure of the Earth system

Estimated Time: 1 class period

Materials

For teacher demonstration:

An image or plastic bright red shrimp

One for each student or group of students:

1 blue plastic cellophane or sheet- 8.5" x 11"

2 sheets of black construction paper*- 8.5" x 11"

Various colored construction paper* (see below)

To be shared:

Scissors

Scotch tape

White glue

*Construction paper:

White, light blue, bright red, orange, green, yellow (1 sheet per student)

* Black will be used with left-over pieces from above sheet

(1 sheet can be divided into 21 pieces)



Preparation

Precut the blue plastic cellophane into sheet size (8.5" x 11"). Cut the colored construction paper- One sheet can get divided into 21 pieces. (students can cut them into shapes before the experiment) Familiarize yourself with the activity by making an example. Prepare materials.

Background Information

For all the sunlight pouring down on the ocean's surface, none reaches the deep ocean bottom. Some light reflects off the surface and some is scattered.

Scientists use light penetration to describe different habitats in the open sea: the upper sunlit zone, the middle twilight zone, and the deepest zone of darkness.

The photic or sunlit zone is the most active layer of the ocean. In this shallow region, storm waves, tides and currents keep the water in motion. In central California, the photic zone can reach 300 feet down. These waters are rich with life: microscopic plants called phytoplankton grow in this well-lit region using light energy for photosynthesis. Plankton animals-like copepods and fish larvae are also abundant here, feeding on plants or on the plant-eaters.

Below the sunlit region is a twilight zone of dim light. The mid-water zone extends from about 300 feet to 3,500 feet below the surface. Many fish such as the hatchetfish are found in the twilight zone. These creatures are migrators that swim up each night to feed on the richer photic waters above and return to the depths each day.

The deepest zones never see the light of day. In the darkness below 3,500 feet, the waters are cold and rich in nutrients, but without light. There is no plant production. Instead, the deepest organisms eat other deep sea animals or depend on other food raining down from shallower waters.

Procedure**1. Introduction to the submersible on the top layer of the ocean.**

- a. Explain to students you took a trip down the mid-ocean. Using the submersible, a special underwater vehicle, you descended into the ocean. As you went deeper, you noticed it was getting colder and there was less light. There was also pressure pushing all around the submersible.

2. Mid-ocean as the middle layer in the ocean.

- b. In the mid-ocean, tell your students you saw all sorts of amazing blue light fireworks from bioluminescent animals. Using a special collecting tool and container from the submersible, you carefully collected a black shrimp that swam by. As you were collecting it, it spilled (threw up) bright blue light from its mouth at you but you were still able to get it. (now bring out the bright red shrimp). Here it is. (show it to your students)

3. What happened to the color of the shrimp and why was the light in the ocean light blue?

- a. Tell your students that they will figure out what happened in a color experiment.
- b. Pass out the materials. All students should receive two pieces of black construction paper, each piece of colored paper, 2 sheets of cellophane, and share tape and scissors.
- c. Show an example without the colored pieces inside. Explain to students that the bottom black sheet will be the ocean background. They will be cutting out the other black construction paper into a frame (about 1" from all sides). They will be taping the first cellophane sheet to the frame (like a window) The two black sheets will be connected together by the top hinge (tape together). This is like a window into the dark ocean. Have them cut out round shapes for each colored piece of construction paper. This is to represent marine creatures.

- d. Have them pull up their windows, arrange & glue the colored pieces onto the black bottom construction paper. Have them squint their eyes and write down which color is brightest to dimmest.
- e. Then have the students put down the windows or water layer (representing the ocean) and compare their findings. (one column should be their hypothesis and the other the results) Have them write down why they thought this occurred. (Answer: Students will observe that the color black is the least, then red, orange, yellow, blue, and white) Colors will also change- orange will turn into brown, etc..
- f. Have the students discuss and explain their findings. So that's what happened to the bright red shrimp. It turned darker with the blue filter similar to what happens in the ocean. The blue light is the color which can be seen the best, thus the most useful.

Assessment

Use student responses and activity sheets to gauge student understanding.

Some jellyfish have red stomachs. Since they are transparent & you can see right through them already, why would they have this characteristic? Because they might be invisible but the prey that they eat might not be. So when they eat their prey and it goes into their stomach, they can still be invisible

For Grades 5-6th

Overview

There are many red organisms in the ocean because they become invisible in the ocean. But black organisms are also undetectable as well. Ask the question: Why aren't all red animals just black?

Procedure

Ask students the above question and ask them to think about how you make black. Discuss reasons.

Background Information

Black is created by taking every color (except white) and mixing them together. It takes a lot of energy. Red takes less energy to create which is why there are so many red organisms in the ocean. They can be virtually undetected and not waste much energy, specifically in an environment where it is difficult to acquire energy such as food.

Here are some organisms that are red or parts of their body are red.

Red Organism Chart

Bloodbelly comb jelly	(Lampocteis sp.)	jellyfish relative
Giant ostracod	(Giganocypris agassizii)	crustacean, a crab relative
Giant red mysid	(Gnathophausia ingens)	crustacean, a crab relative
Johnson's sea cucumber	(Parastichopus johnsoni)	echinoderm, a sea star relative
Red sea fan	(Swiftia kofoidi)	echinoderm, echinoderm, sea star relative
Sergestid shrimp	(Sergestes sp.)	crustacean, a crab relative
Deep sea amphipod		cnidarian, a jelly
Deep water jelly	(Periphylla periphylla)	cnidarian, a jelly
Krill (Euphausia sp.)-		crustacean, a crab relative

* Descriptions of these animals can be found on the Monterey Bay Aquarium's website http://www.mbayaq.org/efc/living_species/. Students can have access to great photographs and some good, basic information

7 Structure of Life

Organizing “Glowing” Organisms?

A Unifying Concepts and Processes Activity

Focus Questions: *How would you group bioluminescent animals? By color, characteristics, behavior, or shape?*

Overview

All living things have special characteristics that make them unique when compared to other living things. Scientists organize life by their similar characteristics but what are the other factors? Students will learn about existing classifications of organizing organisms. Students will create their own structure based by other factors such as size, shape, etc..

Concepts

- Understanding how scientists organize life
- Reason why the universal system is so vital
- Organize and create own life structure using bioluminescent creatures

Objective

- Students will understand that scientists organize life and how they do it
- Students will understand the system would be confusing without being universal
- Students will understand scientific organization

Alignment with National Science Education Standard

Unifying Concepts and Processes

- Systems, order, and organization
- Form and function
- Models and explanation

History and Nature of Science: Content Standard G

- Science as a human endeavor
- Nature of Science
- History of Science

Estimated Time: one class period

Materials

- One for each group of students:
 - Precut and photocopied animals from the field guide
 - Poster board
 - Glue or tape
 - Black marker

Preparation

Select and photocopy about 10 animals in the field guide (per group of 5 students). Familiarize yourself with the procedure. Prepare materials.

Background Information

Taxonomy is the scientific discipline which organizes the largely diverse world of organisms. This scientific structure allows scientists to discuss any organism and to specify which one it is.

Unlike most animals in the deep, the black loosejaw fish can see different colors. Because of this unusual ability, it can see the beam of red light which shines out from the light organ beneath its eye. Since most other animals in the deep sea can only see blue light, they are unaware when the loosejaw is sneaking up on them, using its red bioluminescence like a sniper scope to see without being seen.

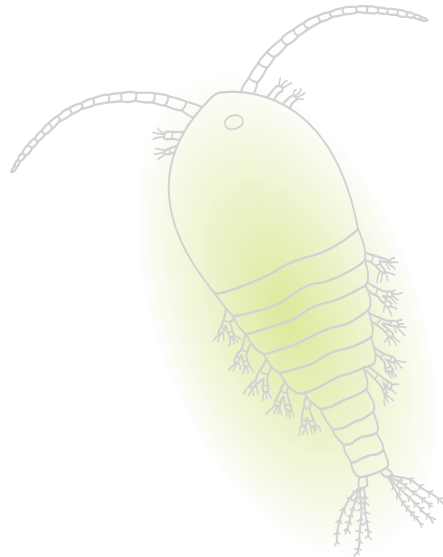

There are two divisions in this field:

1. Classification is the arrangement of organisms into specific groups. The following terms represent how organisms are classified.

Kingdom	Animalia
Phylum	Chordata
Class	Mammalia
Order	Primate
Family	Hominidae
Genus	Homo
Species	sapiens (or better known as humans)

Example of a firefly:

Observing characteristics:	Organizing system:
Gives false signals	Genus Photuris
Ability to glow	Family Lampyrida
Sheath wings	Order Coleoptera
Six legs	Class Insecta (insect)
Three body parts	
Jointed legs	Phylum Arthropoda (arthropod)
Hard exoskeleton	
Multi-cellular creatures	Kingdom Animalia (animal)

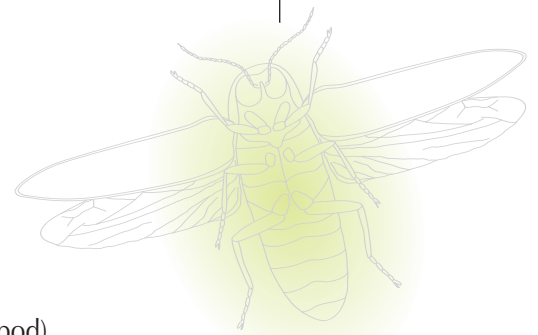

2. Nomenclature is the process of naming organisms. All living creatures are given a scientific name which consists of two words. Scientific names are often in Latin, which is the scientific universal language, and monitored by an international agency to prevent duplication.

Example: Vampire Squid (*Vampyroteuthis infernalis*)

(In this procedure, the genus is always first and capitalized while the species is not.)

In this case, *Vampyroteuthis infernalis* translates to vampire squid from hell, due to its wing-like fins and enormous eyes. These features actually help the creature to locate prey in the depths of 3,000 feet.

Procedure

1. Introduction to Taxonomy

Explain to the students that common names are generally used in everyday conversation but they don't identify a specific species. Many plants and animals have more than one common name. This can become pretty confusing, with over 800,000 insect species alone.

2. Organizing "Glowing" Creatures

a. Divide students into groups of five. Each group will organize their organisms (see field list).

Here are some examples:

- 1) By size- 3 groups-large, middle, & small
 - 2) Uses of bioluminescence- defense, finding mates, & finding food
 - 3) By animal characteristic- same amount of fins, etc..
 - 4) Colors- organisms with blue light, yellow light, etc..
- * have groups color and then organize their organisms
- a. Have students glue down their findings on the poster board and display it at the front of the class.
 - b. Question each group- What did you find difficult in organizing your animal?

Assessment

Use student responses and activity sheets to gauge student understanding.

For Grades 5 – 6th

Overview

In addition to the above activity, add an organism which does not neatly fit into each category such as the railroad worm, which has both red and green bioluminescent lights.

Procedure:

- 1) Add the extra “problem” organism into each category.
- 2) Inquire to students how they organized that “problem” creature
- 3) Talk about how taxonomy as an ongoing science.

This system wasn't always this organized. By the beginning of the 18th century, people were using Latin to name organisms. The system was working but people were using Latin to name organisms in a descriptive way (Ex. Peppermint plant- Mint with flowers in a head; leaves oval-shaped and with spikes). It was too confusing. In 1753, Swedish naturalist Carolus Linnaeus introduced a two-word system of naming organisms. This came to be known as the Binomial System of Nomenclature (binomial- two names)

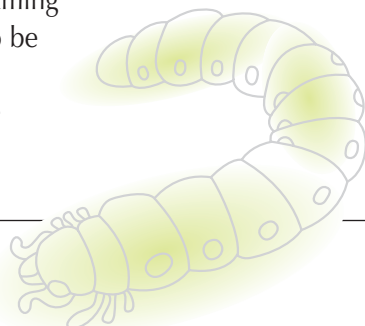

What happens when you find a new species? The process of formally describing a new species is to first make sure it hasn't been named and discovered yet. After researching other published manuscripts and research, scientists thoroughly examine other similar species in order to describe their structure and range of variation. When you have finished a detailed description of the new species, you submit it for publication in a scientific journal. The manuscript will be reviewed by experts in that field. Some manuscripts are rejected but if you have done your homework, your paper will become published. Then you can name your “new” species!

8 Defense/ Survival & “Glow”

Belly Lights, Burglar Alarm, & Vomiting?

A Science Activity

Focus Questions: *How can belly lights, burglar alarms, & vomiting assist a marine bioluminescent animal to survive?*

Overview

From camouflaging belly lights, calling for help, and vomiting, students will understand how these bioluminescent defense methods are used to help an animal survive. In this activity, students will use their creativity to act out these defense methods.

Concepts

- The three main “glowing” defense methods
- Change in light affects the light intensity of a “glowing” creature
- Bright light can aid in survival

Objective

- Students will learn the three main bioluminescent defense methods
- Students will understand how light intensity change affects the light of the animal
- Students will understand how bright light can aid in survival

Alignment with National Science Education Standards

Life Science: Content Standard C

- Characteristics of organisms
- Organisms and environments
- Structure and function in living systems
- Diversity and adaptations of organisms

Estimated Time: one class period

Materials

- One popsicle stick (1 per person)
- White cardstock (2 per person)
- Glow stick (1 per person)- (See Resources)
- Hand held hole puncher
- Scissors
- Tape

Preparation

Prepare materials

Background Information:

Here are the three main bioluminescence defenses:

Blinding or Distracting

Many ocean creatures can release blinding blue bioluminescence into the face of a predator. The bright red decapod shrimp will actually “vomit” the light from its body in the face of its attacker as it flips backwards to escape in the dark ocean, similar to the way a squid will squirt out black ink to distract to get away.

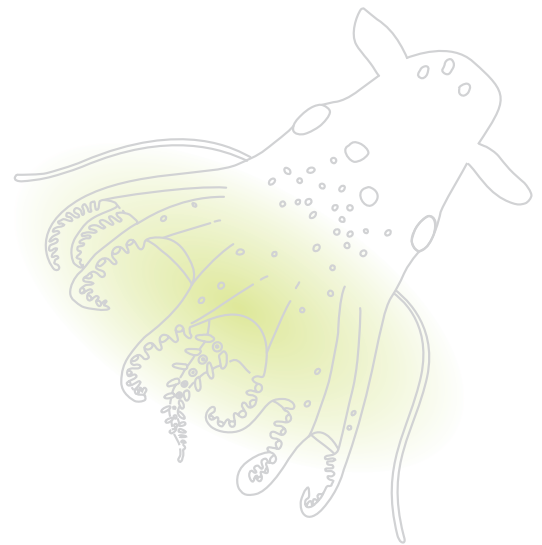

Burglar Alarm

In the ocean, like on land, smaller animals try to hide from larger animals to avoid being eaten. If a bioluminescent animal does get caught by a larger animal, they may use their bioluminescence like a cry for help. But why would an animal want to attract more attention to themselves? Because they might attract the attention of an even larger animal who would rather eat their attacker. This is called the burglar alarm.

Counterillumination

There are no trees or bushes to hide behind in the wide open ocean so animals find other ways to hide from hungry predators. What happens to an animal swimming at depths where sunlight or moonlight shine through and can easily spot a dark shadow against that light? Think about when you've gone swimming and have looked up to see someone above you. Many animals use bioluminescence to break out their silhouette and make it harder for them to be seen. Like a leopard's spots or zebra's stripes, this use of bioluminescence makes it harder for predators to see the real outline of their potential prey. But what happens when the intensity of light dims? It becomes easy again for a predator to see it. So the bioluminescent animal adjusts its light to match the intensity of other light. This is called counterillumination.

Procedure**1. Introduction to bioluminescence as defense.**

Explain that animals use bioluminescence in many ways to help defend themselves against predators. The three main ways are:

- blinding and/or distracting
- burglar alarm
- camouflage/ counterillumination

2. Focusing on one type of defense such as the belly lights

- a. Explain to students they will be creating a fish with belly lights. Pass out materials. Have your students cut out the two pieces (one for each side.) They will use the hole puncher to punch out the photophores. Tape the two pieces together with the (lighted) light stick inside, and put the popsicle stick to hold them up.
- b. Turn off the lights and see all the belly light fishes.

Assessment

Use student responses and activity sheets to gauge student understanding.

5 – 6th Grade**Overall**

Students will create a story/ script in which they will act to express one of the three different types of bioluminescence as used in defense.

Procedure

Have students divide into groups. Explain to each group they will create a story/ script in which they will act to express one of the three different ways bioluminescence is used in defense.

9 Locating Mates & “Glow”

Firefly Language: flash! (pause) flash! (pause)?

A Life Science Activity

Focus Questions: *Why do fireflies flash their lights? What kind of codes do they make?*

Overview

On warm summer nights, have you ever seen the small yet numerous green or yellow lights that blink on and off just after sunset? Have you ever wondered why some of these lights swirl in the dark sky while other lights flicker among meadows or lawns? Most people know that these mysterious lights are caused by fireflies. However, male and female fireflies actually use their “glow” to communicate to one another. Using specific codes, students will learn more about these amazing living light creatures and create their own type of “language.”

Concepts

- Light aids in communication
- Male and female fireflies locate and recognize their mate through light flash patterns
- Creating “language” through codes of light

Objective

- Students will learn that finding a mate in the darkness can be just as difficult as finding food
- Students will learn that bioluminescence can help males and females find each other
- Students will learn that fireflies communicate to their specific species

Alignment with National Science Education Standards

Content Standard C: Life Science: Content Standard C

- Characteristics of organisms
- Life cycle of organisms
- Organisms and environments
- Structure and function in living systems
- Diversity and adaptations of organisms

Estimated Time: one class period

Materials:

One for each group of students:

Activity sheet

Pencil/ eraser

Preparation

Review activity, prepare materials

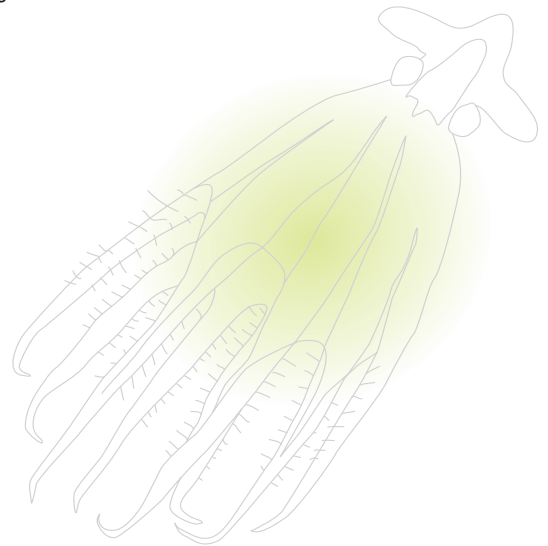

Background Information

Fireflies are not actually flies but belong to the beetle family Lampyridae. Although fireflies are a type of beetle, they are unique in their production of bioluminescence. About two-thirds of the 2,000 species of fireflies within the Lampyridae family have the ability to create light.

An adult firefly’s light is created by an organ called a lantern. This lantern is located on the underside of the insect’s abdomen, the third segment of its body. The actual flashing of the firefly’s light is controlled by its nervous system. Nerve impulses are transformed into chemical messages created by bioluminescence. Chemical messages cause fireflies to start or stop their bioluminescent chemical reaction.

In many species of fireflies, the light does not glow continuously but flashes as in a kind of code. Scientists have discovered that the fireflies use their light to find and locate one another. Each species has its own code to help locate its own species. Some are very simple, consisting of a single flash of light repeated at regular intervals. Others are more complicated groups of flashes that vary in light intensity and speed.

Most fireflies set out to look for mates just after sunset on evenings in spring or early summer. The males fly among the edges of woods, fields, or along streams. With their enormous eyes and hanging abdomens, male fireflies continuously scan their flying range. Female fireflies do not seek their mates by flying but usually perch on leaves or grass stems, looking for a familiar signal flashing in the night sky.

Different kinds of fireflies have different patterns of flashing lights. The most common type of firefly in the eastern United States is called the *Photinus pyralis*. This type of firefly has a yellow light that flashes every six or seven seconds. Each flash lasts about half a second. While his light is on, the male swoops down and up again, so that he makes a glowing J-shape in the sky. The female sees the flying light, blinking in just the right pattern, and she waits about two seconds to blink back. Her light is much smaller but the male's keen eyes can spot it. He flashes out his signal and the female responds. After a time or two more, he flies down to meet her.

What's the difference between a male and female firefly?

Some characteristics in male fireflies that differ from female fireflies include a smaller body, larger (often enormous) eyes, the use of flight, and the specific location of the lantern. On male fireflies, the lantern is located in the last two segments of their abdomen, while the female's is located in the second to last segment. Female fireflies flash their lights while on the ground. Some species of female fireflies are even wingless, hence the "glowworm" name.

Procedure

1. Introduction to communication

Introduce communication as giving or receiving information to understand one another. Humans use their voice or gestures to understand one another. But what if someone couldn't hear or see? What ways do they have to communicate? (deaf- sign language & blind- braille) Explore different ways to communicate to one another. Also introduce that just one person knowing the language doesn't work. It only works when you know the language and the people that you need to communicate with also know that system.

2. Male and female fireflies communicate with codes

Introduce communication with fireflies. Fireflies flash their lights in a kind of code. Fireflies need to communicate with their own kind; specifically, the males and females need to locate and find each other.

3. Different kinds of fireflies use different codes

The male flies around in the sky with its light hanging down so that females can see it better. The female waits until she sees the special pattern from a male of her own kind. Then she flashes her own pattern back. If the female flashes the right code back at the male, the male flies closer and flashes his code again. This "conversation" continues until they locate each other and mate.

4. Students create their own code

- Explain to your students that they will be constructing their own language of lights. But instead of lights, they will be using their hands. Closed fist means dark and opened hand represents the light.
- Divide the class into two. Each group will come up with their own set of codes on the activity sheet.
- Sub-divide the two groups. Have groups of the different sets stand on opposite sides of the room. Use their hands- (closed fist- dark; open hand- flash)
- Tell one of the groups to ask a question from the activity sheet. This will go back and forth until each group can figure out each others codes.

Living Light "Language"- Group A	Group B
Yes	<i>Example: flash</i>
No	
Maybe	

Sample Questions (yes, no, maybe):
Are you a boy?
Are you a girl?
Are you wearing white?
Are your eyes brown?

More Complex:
Example: Don't know- <i>Flash, Dark, Flash, Dark</i>
Leave me alone- <i>Flash, Flash, Flash, Flash, Flash</i>

Assessment

Have a group discussion about any difficulties or problems in trying to communicate with the different groups. Use student and the activity sheet to gauge student understanding.

For Grades 5 -6th

Additional Information

There is a common kind of firefly called Photurus that doesn't play by these rules. Although their own kind have their own kind of code, after she mates, she uses the answering code of different species to get males to come to her. Then she pounces on and eats the male. She actually has many to choose from because there are many males looking for females, and only a few females answering back. To protect themselves, some males actually change their codes when they come down to answer the female. If he sees an answering flash pattern, he will fly down to investigate. Then he will try to persuade her to mate with him rather than eating him.



10 Finding Food & “Glow”

Cookie-Cutter Shark & Vampire Squids?

A Life Science Activity

Focus Questions: *What are predators? What is prey? How do bioluminescent animals have an advantage over non-bioluminescent creatures in finding food?*

Overview

From mysterious cookie-cutter sharks and vampire squids, students will learn all about the ways creatures use their bioluminescence to find food. In the predator/prey freeze tag activity, students will also understand the advantages of bioluminescent creatures over non-bioluminescent creatures (in a constantly dim or dark environment).

Concepts

- Prey and predator
- Utilizing light to locate prey
- Bioluminescent vs. non-bioluminescent organisms

Objectives

- Students will learn how bioluminescence creatures use their light to locate prey
- Students will learn different light devices aids in different ways
- Students will learn bioluminescent creatures have an advantage over non-bioluminescent creatures.

Alignment with National Science Standard

Life Science: Content Standard C

- Characteristics of organisms
- Organisms and environments
- Structure and function in living systems
- Diversity and adaptations of organisms

Estimated Time: one class period

Materials

3 pieces of cloth

Preparation

Familiarize yourself with the procedure. Similar to freeze tag, the students will perform this activity outdoors on a playground.

Background Information

In the deep ocean where food is scarce, animals have adapted to make the most out of every meal. Compared to some muscular and sleek fish in the upper level of the ocean, deep sea fish are often small, have weak muscles, and a light-weight skeleton. Predators are creatures which prey upon another or others. Prey are any creatures hunted or seized for food by another animal. Many predators in the deep ocean do not need much food to support their small bodies. They also have learned to wait for prey to come to them instead of wasting energy by hunting the prey.



Procedure

1. Introduction to bioluminescence as an advantage.

- Explain to students that animals that use bioluminescence have a distinct advantage over animals that don't have bioluminescence.

2. Prey/ Predator Activity

- Student will learn about predators and prey through an interactive activity similar to freeze tag. However, some students will carry a cloth (representing the bioluminescent animals) and can only be frozen after three tags. Lead students out into the playground. Explain the rules- 5 students will be the "predators" and the rest will be "prey." However, the three students who are the bioluminescent creatures (carrying the cloth) cannot be frozen until they have been tagged three times and they can also be the only ones to "free" the other prey.
- Have a destination area and put the predators in the center. Explain that both end sides are the safe zones. Students will have to run to get to the other side without being tagged. If they are tagged, they can only be freed by the "bioluminescent animals."
- Discuss the prey/ predator game when back in class.

Assessment

Use student responses and activity sheets to gauge student understanding.

11 Practical Applications: People & Bioluminescence

Can Bioluminescence Reveal a Hidden Submarine?

A Science and Technology Activity

Focus Question: *How can bioluminescence reveal a hidden submarine?*

Overview

Students will understand how bioluminescence can reveal a hidden submarine.

Concepts

- Submarine as a hidden underwater vehicle
- Masses of bioluminescent plankton can reveal an object or objects
- Researchers learn from bioluminescent creatures

Objectives

- Students will understand the workings of a submarine
- Students will understand bioluminescent creatures can be beneficial to humans
- Students will understand people learn from studying bioluminescent creatures

Alignment with National Science Education Standards

Science in Personal and Social Perspectives: Content Standard F

- Personal health, populations, resources, and environments
- Natural hazards, risks, and benefits
- Science and technology in society

Science and Technology: Content Standard E

- Abilities of technological design
- Understandings of science and technology

Estimated Time: one class period

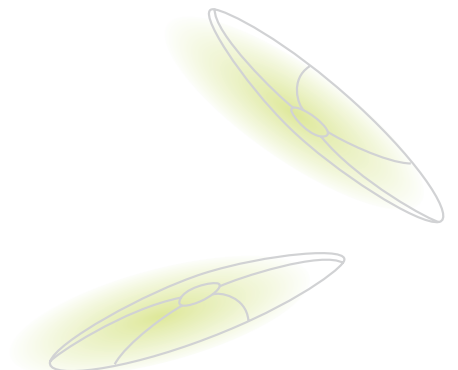

Materials

Lined writing paper
Pencil/ eraser

Preparation

Prepare materials. Review procedure.

Background Information

Humans are finding new uses for bioluminescence all the time. The navy is working on ways to track ships and submarines. The fishing industry locates schools of fish by observing the glowing trails when they swim through the water with glowing dinoflagellates. The luciferase and luciferin used in tests are obtained from the bodies of fireflies. Each summer, hundreds of children go out to the woods and fields to work as part-time firefly catchers. There is even a chemical company that supplies them with nets, special storage cans, and pays them to catch fireflies.

There seems to be no end of ways that animals use their chemical lights. And now humans have also learned to use these lights. Scientists use the chemical light from jellyfish to see inside cells, the light from bacteria to test for pollutants and the light from these and other organisms as alternatives to radioactive labels.

Although too tiny to see without a microscope, there are tons of plankton that live in the ocean. At the bottom of the food chain, plankton are important because many animals feed on them. Other animals feed on those animals and so forth. Some of these plankton make their own “glowing” lights. Some “glow” to scare off predators. They also glow to attract even larger predators to eat the creatures that are eating the plankton. In the case of the submarine, the plankton were trying to scare it away, thus revealing the vehicle with its greenish glow.

Assessment

Use student responses and activity sheets to gauge student understanding.

12. Current Research**How can I be a Junior Scientist?*****A Science Activity***

Focus Questions: *What do you think of when you hear the word “scientist?” Who are the scientists of **Glow: Living Lights** and what do they do?*

Overview

When we hear the word, “scientist,” what does our imagination conjure up? Wild hair and fizzing chemicals? Scientists can be male or female, come from various backgrounds, and work in various environments. The only common connection is that scientists are curious. They use their curiosity to understand this world by observation, asking questions, doing experiments, and seeing what happens. Meet some of the **Glow: Living Light** scientists and learn some of their research. From creatures that make light to survive, we are discovering new ways to see into the unknown and perhaps aid our own survival. We have just started to explore the dark oceans. There is much more research to be done.

Concepts

- Common misconceptions of a “scientist”
- Scientists in **Glow: Living Lights** & their contributions to the understanding of bioluminescence
- Potential research & careers in science

Objectives

- Students will understand a scientist can come in all different shapes and sizes
- Students will understand current research on bioluminescence
- Students will understand potential research & careers in science

Alignment with National Science Education Standards

Science as Inquiry: Content Standard A & B

- Abilities necessary to do scientific inquiry
- Understandings about scientific inquiry

Science in Personal and Social Perspectives: Content Standard F

- Personal health, populations, resources, and environments
- Natural hazards, risks, and benefits
- Science and technology in society

Estimated Time: one class period

Materials

- Internet access
- Paper/ pencils
- Colored pencils or markers

Preparation

Review procedure. Download the images of **Glow: Living Lights** scientists.

Curatorial Expertise

James F. Case, Ph.D., *Marine Science Institute, UC Santa Barbara*

James F. Case is a leader in the field of bioluminescence with interests both in marine and terrestrial forms. His extensive writings include over 140 peer-reviewed scientific publications and three books. Currently, Dr. Case is a Research Professor in the Marine Science Institute at University of California, Santa Barbara. Active research projects include counter illumination on midshipman fish, bioluminescence prediction in the coastal region, and firefly bioluminescence communication.

Edith A. Widder, Ph.D., *Bioluminescence Department, Harbor Branch Oceanography Institution*

Edith A. Widder is a leading research scientist who has conducted research on bioluminescence for over 20 years. In addition to being an author on over 50 peer-reviewed scientific publications, Dr. Widder has also recently produced a children's book on bioluminescence, "The Bioluminescence Coloring Book" and an educational video, "Bioluminescence: Secret Lights in the Sea." Currently, Dr. Widder is Senior Scientist and Director of the Bioluminescence Department at Harbor Branch Oceanographic Institution in Fort Pierce, Florida. Her research interests in bioluminescence developed out of her experience piloting the single-person submersibles, Wasp and Deep Rover.

Steve Haddock, Ph.D., *Monterey Bay Aquarium Research Institute, Monterey Bay Aquarium*

Steve Haddock is a scientist specializing in bioluminescence and zooplankton. In addition to numerous peer-reviewed scientific publications and abstracts, Dr. Haddock has created the bioluminescence web page. (see Resources). Currently, Dr. Haddock is a scientist at Monterey Bay Aquarium and is doing research on the bioluminescence and ecology of deep sea and open-ocean ctenophores, siphonophores, and medusae. His focus is on trying to clone novel photoproteins from these group of creatures. Other research interests include blue-water diving, and submersible work on bioluminescence in zooplankton and marine snow.

Procedure**1. Introduction to a scientist.**

- a. Tell students they will be drawing a “scientist.” Ask them what they think a scientist looks like? What are they wearing? What type of instruments or tools is that person using? Where do they work? (results will vary but a typical drawing might be a “mad scientist” in a lab coat with fuzzy hair and exploding chemicals)
- b. Have students display their drawing. Ask students to examine the drawings to see overall similarities and differences. As a class discussion, ask students to point out these characteristics.
- c. Inform students that scientists can be male or female, come from various ethnicities and backgrounds, use various instruments, and work in all different types of environments. Lead students toward the definition of a scientist and related terms.
- d. Discuss science as a process. First is the inquiry and observation. A person is curious and wonders “why?” about someone or something. Next is the hypothesis where a person comes up with a testable explanation. Then the person experiments to test his or her own hypothesis. If the observed results do not match the hypothesis, the person forms a new hypothesis and tests again. Allow students to realize they have already learned this through their previous experiments.

2. Introduce Glow: Living Light scientists: Dr. James F. Case, Dr. Edith A. Widder, and Dr. Steve Haddock

- a. Introduce the three curatorial experts from **Glow: Living Lights** exhibit.
- b. Explain to students how over the last decade, scientists have observed and researched how deep-sea animals produce and use their light. Researchers such as Dr. Edith Widder have used special underwater vehicles such as the Johnson-Sea-Link I & II to regularly voyage to the depths to understand the unknown.
- c. Inquire of students why they believe scientists have only recently begun to study these amazing creatures. The reason why is because of technology. The evolution of specialized equipment such as manipulator arms, suction devices, and rotary plankton samplers has made it possible for crew people to accomplish almost any work from submersibles that once were done only by divers. The Johnson-Sea-Link are further outfitted with active sonar, laser aimed still and broadcast quality video cameras, and Harbor Branch-developed xenon arc lights. The arc lights approximate sunlight, illuminating underwater scenes in true color, and near daylight conditions, even in the darkest seas.
- d. Explain to students that there is still much needed research in the deep ocean.

Assessment

Use student responses and inquiry to gauge student participation and understanding.

For Grades 5 – 6th

Ask your students to imagine deep sea exploration like exploring the classroom and picking up every single piece of dust with a tweezers. Where is all the dust? Not only are they under the desks, in hidden crevices, and on the ground, they are constantly moving with the breeze and other conditions. What type of equipment and other models would help you better study the deep ocean?

Terrestrial

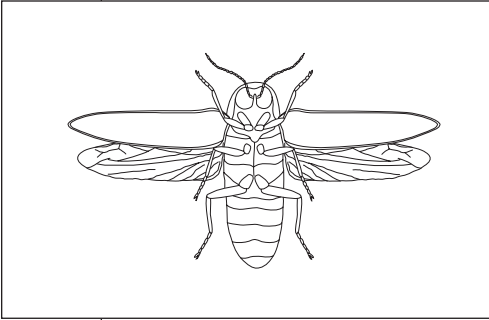

Fireflies – Fireflies are the most common bioluminescent creatures. Fireflies, from the family Lampyridae, are not flies but beetles. Different species of these flying beetles use different flash pattern codes to locate their own species. In the night or late sunset, male and female fireflies flash back and forth until they can locate each other.

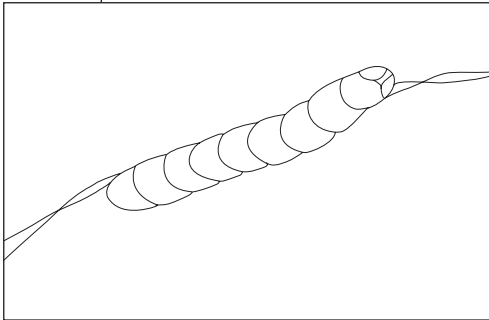

Fungus Gnat Larvae (3 mm to 1 inch) – Fungus gnat larvae are a type of bioluminescent fly larvae. The small fly larvae, commonly called a glowworm, live in caves and overhangs. A well-known fungus gnat larvae site is in the Waitomo Cave, New Zealand. Thousands of bioluminescent larvae hang from the ceilings of the caves, and their light helps attract and catch food. Like spiders, they spin sticky threads which hang down as fishing line to catch flying insects.

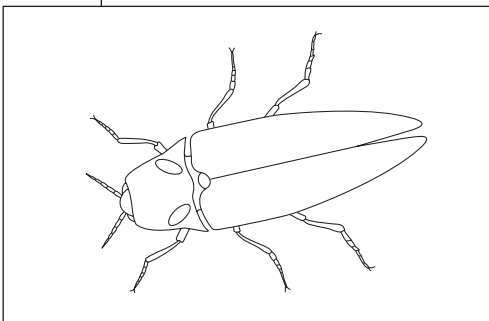

Bioluminescent Click – A click beetle makes a click noise as it springs to turn over from its back. The fire beetle, a type of click beetle, has an orange belly light and two yellow lights on its back. Creatures believe those two glowing spots to be “eyes” from a large animal and stay away from the bioluminescent beetle.

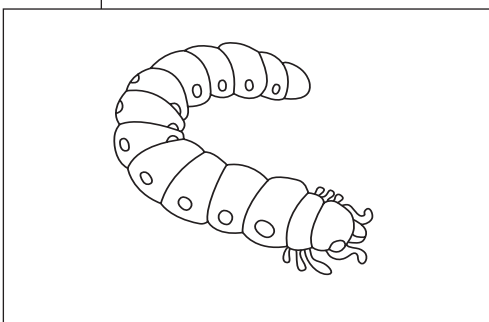

Railroad worms (1.5 inches) – Railroad worms, found in Central and South America, are actually female beetles in larvae form. Their name comes from the remarkable color of their bioluminescence, which consists of glowing red headlights and greenish-yellow “window” lights on each body segment. Railroad worms use their red light as a sniper scope to see without being seen. The railroad worm turns on the greenish-yellow lights to scare away predators.

Field Guide – Terrestrial

Malaysian Land Snail (shell 32.2 mm in diameter) – Malaysian land snails are commonly found throughout Southeast Asia in forests, lawns, and even rubbish dumps. This small snail is regarded as the only land gastropod in the world capable of bioluminescence. The Malaysian land snail has a flashing yellow-green light perhaps used to signal other snails to a food source.

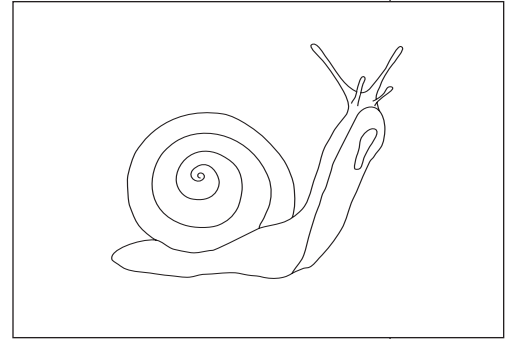

Bioluminescent Fungi – While there are no bioluminescent plants, over forty glowing fungi (mushrooms) have been identified. Scientists believe that bioluminescent fungi such as the jack-o-lantern (*Omphalotus illudens*) and foxfire use their light to attract insects. The insects pick up the mushroom's spores and spread them to other parts of the forest to aid in reproduction.

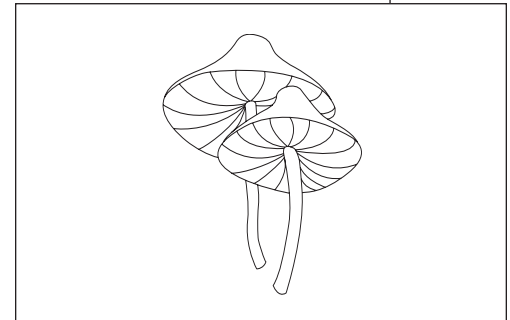

Field Guide – Marine

Marine

Sparkling Seas

Copepods – Copepods are a group of tiny crustaceans. Copepods are so common in the ocean that they are like insects of the sea. Some copepods are bioluminescent. They can release clouds of “glow” into the water from pores on their tails as well as on their heads.

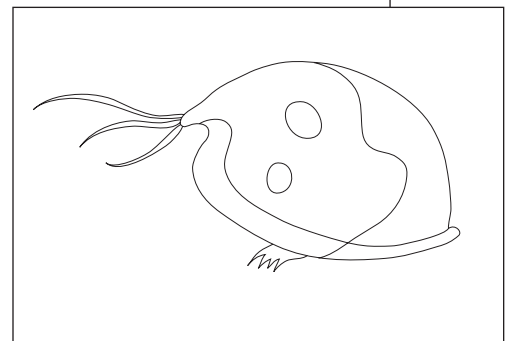

Dinoflagellates – Dinoflagellates are microscopic single-celled creatures. Many are plant-like which means they get their energy from the sun, while others are animal-like because they get their energy from eating other microscopic creatures. Many types of dinoflagellates are bioluminescent.

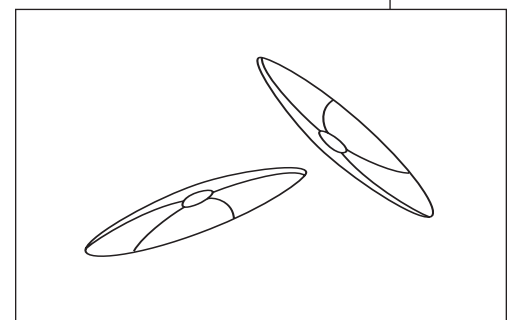

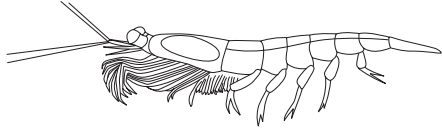

Krill – Krill, a group of small shrimp-like crustaceans, feed on plankton. In return, they are the basic food source of larger animals. In the ocean where there is no place to hide, there is safety in numbers. Krill will gather by the millions and predators become confused by the swirling glowing mass of these animals. In order to stay in their protective swarm, krill signal each other with their light.

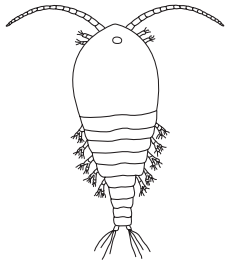

Sea fireflies (ostracods) – Sea fireflies are a class of crustaceans – such as crabs. Tiny in length (0.5 to 5 mm), sea fireflies are the size of a tomato seed. They live on the sea bottom during the day and then go up to feed at night. The males swim around, releasing bright blue bioluminescent drops to find female sea fireflies.

Mid-Ocean and Beyond

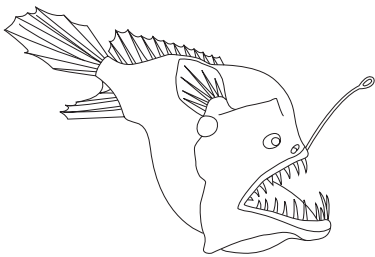

Anglerfish – Most anglerfish live at depths below 1,000 meters in the ocean. They are not streamlined, have huge mouths, and expandable stomachs. Instead of using their energy to find food, the female anglerfish has an elaborate, glowing lure at the end of her fishing rod. The glowing bait attracts small fish and shrimp to her mouth.

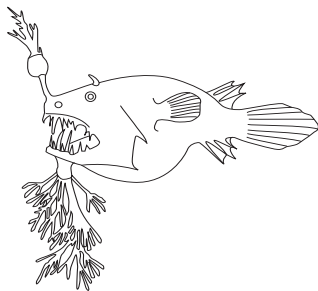

Netdevil Anglerfish – The netdevil anglerfish is a scaleless black fish with a light organ, called an esca, that hangs in front of its mouth to attract smaller animals that it can devour for its dinner. It also has a light organ that dangles from its chin.

Jelly fish – Jellyfish or medusae are a group of invertebrate (without a backbone) animals with a body of almost transparent jelly-like tissue. When attacked, one type of bioluminescent jelly will drop its “living light” tentacle to elude its attacker. While the predator is attacking the dropped tentacle, the animal has a chance to escape. Similar to how a lizard drops its tail, the jelly’s light tentacles are probably regenerated.

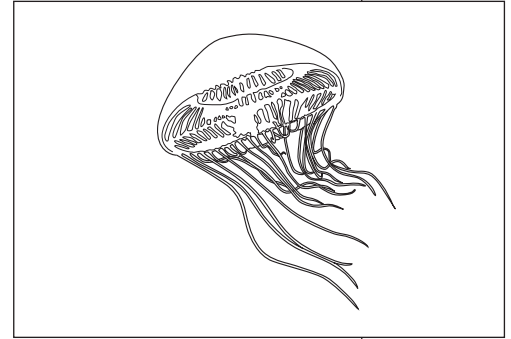

Vampire Squid (15 inches in length) – Not a true squid but a distant cousin of the squid and octopus, the animal known as a vampire squid is rich brownish-black in color and is covered with bioluminescent organs. Also known as the “vampire squid from hell,” this species has the largest eyes of any animal relative to its body size. A six inch squid has eyeballs the size of a large dog. This fish has wing-like fins and photophores.

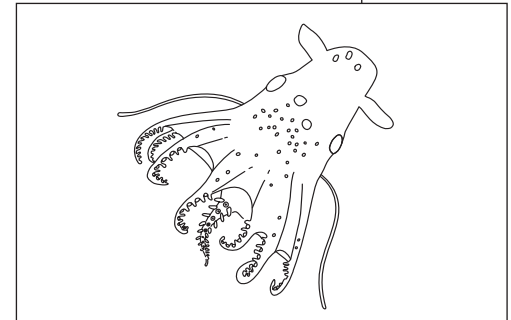

Bioluminescent Squid – Squids, a group of long, slender sea mollusks (animals with a soft, boneless body), have eight arms and two long tentacles. Some squid are “living light” creatures. When attacked, one type of squid squirts a cloud of glowing bioluminescence. The predator might become confused by the sudden glow and the squid would be able to escape.

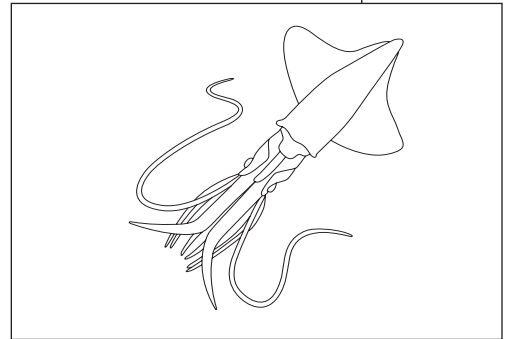

Deep Sea Fish – a general term for all types of fish that live in the deep sea.

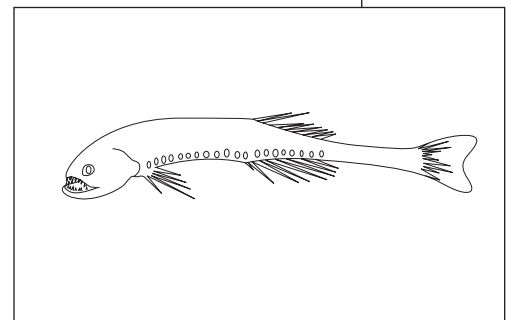

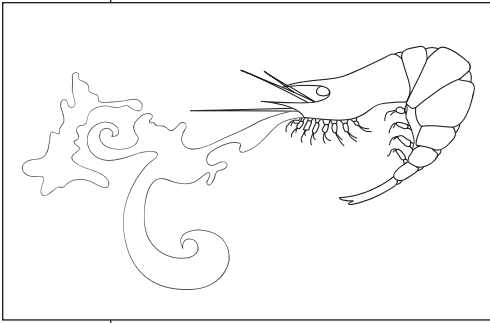

Decapod Shrimp – Shrimp are a large number of small, slender, long-tailed decapods. Although black is a common color for deep sea animals, many animals such as these shrimp are bright red on land. An animal that appears red at the ocean's surface looks black in the ocean depths where the light is blue. Many deep sea animals, like the decapod shrimp, can release bioluminescence into the face of an attacker.

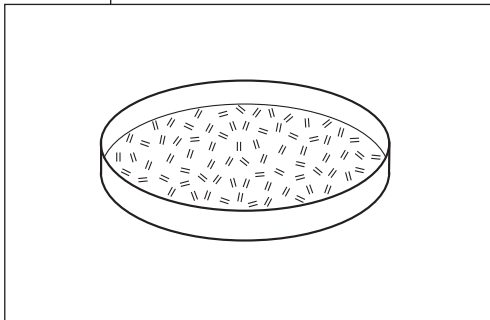

Bioluminescent Bacteria – Some ocean animals do not produce their own light but “borrow” bioluminescent bacteria to use as a light source. In the flashlight fish, bioluminescent bacteria are located in the light organ underneath its eyes. The glowing light is crucial for the flashlight fish's survival, and the fish provide the bacteria a home and food. This mutually beneficial arrangement is known as symbiosis.

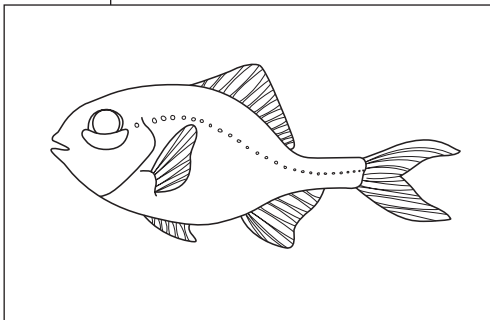

Flashlight Fish (approx. 7 cm) – Flashlight fish live in warm, tropical oceans throughout the world. These creatures live in reefs and rocks near shore, where they hide during the day; they only come out to feed when it is dark. Flashlight fish have light organs under each eye which house about a billion bioluminescent bacteria. They use their light just like a flashlight to help them find food in the dark. They also use their “flashlights” to help bring food to them. Many of the plankton that they eat are attracted to their lights in just the same way moths are attracted to a flame.

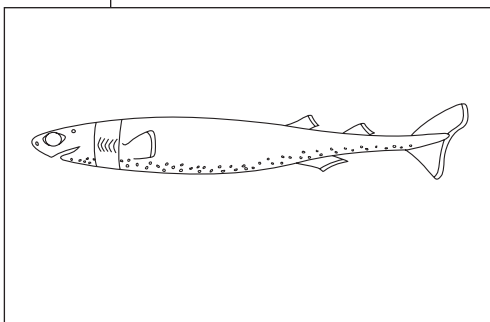

Cookie-Cutter Shark (24 inches in length) – The cookie-cutter shark's name comes from the cookie-shaped piece of flesh that the shark bites out of other animals. The belly of the cookie-cutter shark is covered with thousands of tiny green light photophores, or belly lights. They may use this light to attract the attention of potential prey.

Siphonophores (130 meters) – Siphonophores are linear colonies of individuals connected along a common stem, each with a specialized structure and role. Some individuals propel the colony, while others are involved in reproduction, protection or food capture and digestion. Like colonies of bees, they have up to a hundred individuals.

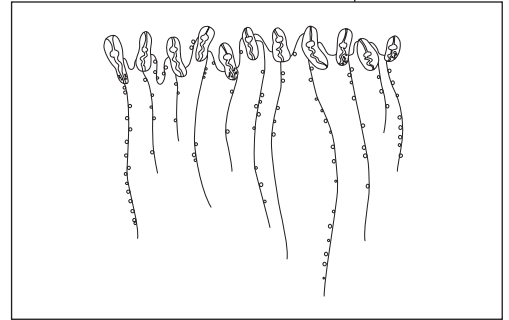

Viper Fish (6 to 6.5 inches) – The viperfish’s mouth contains long fangs and has a jaw which can open very wide to swallow large prey. Thousands of light organs cover the body, fins and head of the viperfish. Light organs are even located in the mouth and in the inner parts of its eye-ball. In addition to all those lights, viperfish also have a luminescent lure at the end of their fishing rod used to draw in prey.

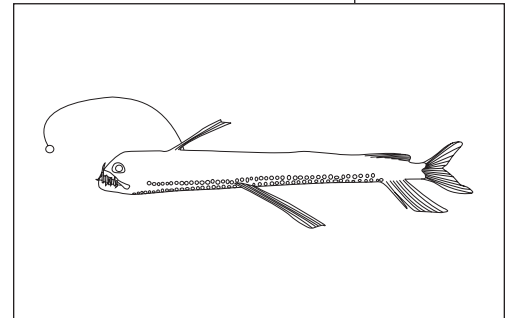

Bermuda Fire (1/2 inch long) - The Bermuda Fire is often called a fire worm. Flashing a green light, fire worms are found throughout the world’s oceans. Like many bioluminescent creatures, fire worms use their lights in attracting mates.

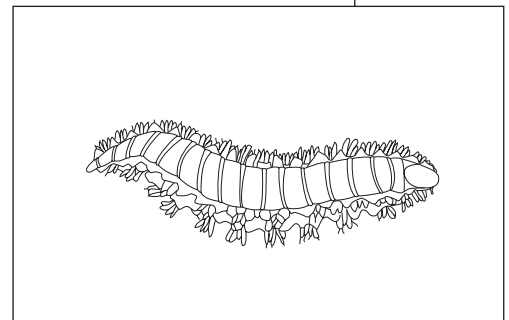

Adaptation – a change of structure, function, or form that improves the chance of an organism to survive

ATP (adenosine triphosphate) – an energy package found in all living cells (ex. blinking our eyes is powered by ATP); an ingredient needed for bioluminescence

“Belly Lights” (see photophores)

Bioluminescence – ability of certain living organisms to produce a cool light through a chemical reaction in their bodies (ex. fireflies); subset to chemiluminescence

BL – short for bioluminescence

Blinding/ distracting – Some BL creatures can release a cloud of blinding bioluminescence into the face of an attacker, like a squid releases an ink cloud to try to escape

“Borrower” – For BL creatures, the term borrower is different from someone who will eventually return something. (see symbiosis relationship)

Burglar alarm – a cry for help to try to attract the attention of an even larger animal (ex. a squid is trying to get away from a large fish (burglar). The BL from the squid attracts the attention of a swordfish (police). The swordfish would rather eat the large fish than the squid so it attacks the fish. The squid is then able to get away.)

Camouflage – to blend into one’s surrounding to avoid being seen by others

Chemical reaction – reaction of chemical properties which convert into other substances (ex. luciferin + luciferase + ATP + Oxygen = light/ Although these ingredients produce light, there are actually very different kinds of additional chemicals in different animals ex. to produce different colors)

Chemiluminescence – visible light produced by a chemical reaction and not accompanied by heat

Chemistry – the science dealing with the composition & properties of substances

Chlorophyll – a chemical in phytoplankton and other plants that capture the sunlight and change it into food

Classification- the arrangement of organisms into orderly groups

Code – For fireflies, a code of flashing light is used to locate and communicate among males and females

Cool light – a chemical reaction inside a bioluminescent animal which can produce energy that is mainly light and not heat (see warm light)

Copepods – a type of zooplankton, related to crabs & lobster; also know as the “insects of the sea” because they are so common; some are bioluminescent

Common name – names generally used in everyday conversation but do not positively identify a specific species

Communication – giving or exchanging information to understand one another

Counter-illumination – using the creature’s BL photophores to act like leopard’s spots which break up the animal’s silhouette, making it harder to see from below (An animal swimming in depths where sunlight/ moonlight filters down from above is otherwise seen as a dark shadow.)

Dinoflagellates- Microscopic single-celled algae: some are plant-like while others are animal-like; Some are bioluminescent; the BL dinoflagellates create many of the flashes of light seen in the ocean at night

Energy- a supply of a usable resource (gas to fuel or fire to light & heat)

Enzyme- a protein produced by living cells

Food chain- a linear sequence of who eats who

Food web – a complex interrelationship of who eats who

Hypothesis – a theory or idea that needs further investigation through scientific study to be proved

Johnson-sea-link I & II – These submersible, from Harbor Branch Oceanographic institution, are primarily used in research in the marine sciences and can operate to the maximum operating depth of 3,000 feet.

Krill – the name of some shrimp-like zooplankton

- Light** – a form of energy which is used with optical vision for sight; created either by heat or by a chemical reaction
- Light sticks** – example of a type of chemiluminescence; a man-made product that when bent and shaken, will produce a similar light reaction as BL
- “Living Light”** – another term for bioluminescence; -bio meaning life & -luminescence meaning light
- Luciferase** (loo-SIF-eh-ras) – an enzyme that sets off the chemical reaction in a bioluminescent animal (see luciferin)
- Luciferin** (loo-SIF-eh-ruhn) – a chemical compound that reacts with oxygen to produce the bioluminescent light (see luciferase)
- Lure** – a device used to attract another creature (ex. An anglerfish has a glowing lure or fishing rod on its head to attract small fish & shrimp into her mouth so she can eat them. They can also be used to draw males to recognize females of their own species)
- Marine** – in the ocean
- Mate** – In the case of BL animals- one of a pair (male & female)
- Mimicry** – imitating the appearance or actions of another creature (ex. The Photurus female firefly mimics of the light flashing of other firefly species to lure males and eats them)
- Morphology** – the study of external form and structures
- Nomenclature** – process of naming organisms
- Nutrients** – simple chemicals which are required for plants and animals to live and grow
- Ostracods** (sea fire flies) – Tiny crustaceans; some are bioluminescent
- Oxygen** – an essential gas we breathe; an ingredient needed for bioluminescence
- Photophores** – Light organs like little lamps on the sides of certain BL animals that create light; many photophores include a lens which help direct the light produced inside, out into the water.
- Photosynthesis** – process in which light energy from the sun is converted into chemical energy by plants. Also makes oxygen that all animals need to breathe.
- Phytoplankton** – a type of plant plankton which gets its energy from the sun (see chlorophyll)
- Plankton** (Greek term for “wanderer”) – Any tiny aquatic animal which drift afloat in the ocean; essential as the bottom of the food chain for other animals
- Prey** – victim of a predator (see predator)
- Predator** – animal that attacks (see prey)
- Research** – systematic study and investigation in some field of knowledge
- Science** – knowledge based on observed facts and tested truths arranged in an orderly fashion
- Scientific name** – Often in Latin as the universal language to name a specific organism to positively identify it
- Scientific study** – a method of research in which a hypothesis being studied by means of careful documentation can be repeated by another researcher
- Scientist**- a person who has expert knowledge of some branch of science, as biology, chemistry, physics, etc..
- Sub culture** – Culture means to grow an organism (like dinoflagellates) in a specially prepared artificial medium. Sub culture means to cultivate from a previous culture.
- Submersible** – A vehicle specifically designed to operate under water
- Substrate** – the base on which an organism lives
- Symbiosis relationship** – A relationship where both organisms benefit from each other.
- Taxonomy** – a scientific discipline which organizes plants and animals through some common factors such as same characteristics, etc..
- Terrestrial** – on land
- Warm light** – light such as a light bulb which uses most of its energy to produce heat
- Zooplankton** – a type of animal plankton which gets its energy from capturing and eating
- Phytoplankton** – some are baby forms of other sea animals like crabs or lobster

Suppliers

Light sticks

Lab Safety Supply 1-800-356-0783

Colors: blue, green, red, orange, & yellow (\$2 each)
(when you bend and shake the light stick mixing the chemicals inside, "cool" light is created similar to bioluminescence)

Carolina Biological Supply Co. (Tel. 1-800-334-5551)

Bioluminescent bacterium kit ("glowing" bacteria)

Catalog #P7-15-4750, price per kit \$10.95
(some maintenance- bacteria need subculture-food, every 3 – 4 days)

Bioluminescent fungus kit (foxfire fungus)

Catalog #P7-15-5798, price per kit \$21.95
(Causes a dim light but fungus lasts for months to years with little effort)

Bioluminescent ostracods (sea fireflies)

Catalog #P7-20-3430, price per 500 costs \$27.80
(instructions are included to separate luciferin & luciferase which produce light when mixed for bioluminescence demonstration)

Bioluminescent dinoflagellates

Center for Integrated Science Education University of Utah, 2480 MEB, Salt Lake City, UT. 84112.
 Tel. 1-801-581-7730, price per bag \$9.00 plus \$5 for shipping and handling *(Some maintenance- needs to be exposed to sunlight 8-12 hrs. daily; excellent organism to study light/ dark cycles)*

For Students

"The Bioluminescence Coloring Book" by Dr. Edith Widder
 ISBN 0-9659686-0-X

Excellent book for all ages; completely accurate information; line drawings for animal reference

"Creatures that Glow" by Anita Ganeri

ISBN 0-8109-4027-2

Excellent introductory book with overall terrestrial and marine organisms; good book for reading to young children; realistic bioluminescent colored drawings

"The Winking, Blinking Sea: All about Bioluminescence" by Mary Batten

ISBN 0-7613-1484-9

Excellent overview of marine organisms along with color photographs

"Nature's Living Lights" by Alvin & Virginia Silverstein

ISBN 0-316-79119-9

Excellent book with interesting facts for older students; blue & white animal drawings; out-of-print, available at some libraries

"Fireflies" by Sylvia A. Johnson

ISBN 0-8225-1485-0

Extensive overview of fireflies including life cycle and color photographs

"The Lonely Firefly" by Eric Carle

Enjoyable introductory book for younger children with colored illustrations

"The secrets of nature's night lights" by Paul A. Zahl.

National Geographic Vo. 140, No.1 July 1971 p. 45

Older yet still relevant information; excellent color photographs

"Light in the Ocean's Midwater" by Bruce H. Robinson

Scientific American Vol. 273 July 1995. pg. 60

Excellent bioluminescent information with pictures

"The Light Connection: Symbiotic Relationships Illuminate Underwater World" by Joe Hlebica

Explorations, Scripps Institution of Oceanography Vol. 4 No.2 Fall 1997 p. 2

Excellent bioluminescent information with pictures

Scientific Resources

Campbell, A.K., 1988. Chemiluminescence: Principles and Applications in Biology and Medicine.

Chichester: Horwood/VCH

Herring, P.J. (Ed.), 1978. Bioluminescence in Action
 London: Academic Press

Marshall, N.B. 1980. Deep-sea Biology, Developments and Perspectives.

New York: Garland STPM Press.

Tett, P.B. and Kelly, M.G. 1973. Marine bioluminescence.
 Oceanogr. Marc. Biol. 11, 89-173.

Widder, E.A. 1998. Bioluminescence. In: "Adaptive Mechanisms in the Ecology of Vision."

Edited by: S.N. Archer, M.B.A. Djamgoz, E. Loew, J.C. Partridge & S. Vallerga. London: Chapman & Hall.

Young, R.E. 1983. Oceanic bioluminescence: an overview of general functions.

Bull. Mar. Sci. 33(4), 829-845

On-line Resources

Explore these links to learn more about bioluminescence.

Websites:

HBOI- More about bioluminescence

<http://www.biolum.org>

Marine bioluminescence page

<http://www.lifesci.ucsb.edu>

Naval oceanographic office (NAVOCEANO)

<http://www.navy.mil/biolum/blwebpge.htm>

Scripps bioluminescence page

http://siobiolum.ucsd.edu/Biolum_intro.html

<http://www.hboi.edu/marine/biolum/html>

http://siolibrary.ucsd.edu/mlatz/Biolum_web.html

<http://lifesci.ucsb.edu/~biolum/>

Other Resources

"Secret Lights of the Sea" video

An excellent video about bioluminescence; amazing footage of bioluminescence in the ocean

Glow

Living Lights

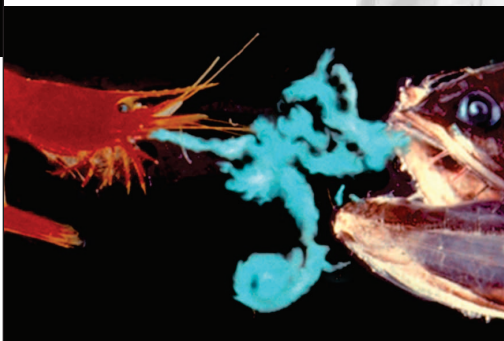
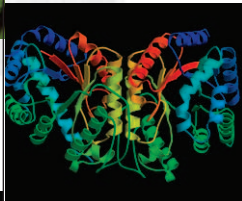
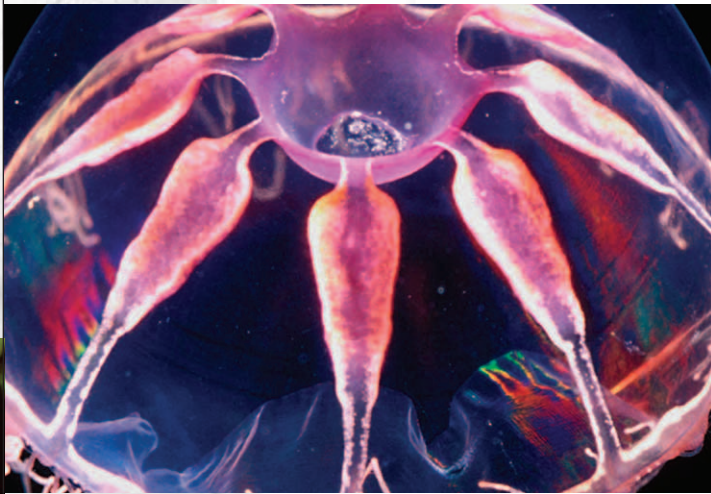
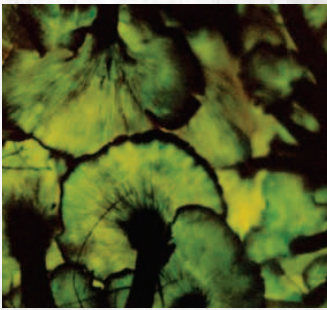

Exhibit

330 Golden Shore, Ste. 250, Long Beach, CA 90802
(562) 495-3000 Fax: (562) 495-3045 www.exhibitq.net